

FOREWORD

Congratulations on becoming the owner of a **KIOTI SL750** Skid-Steer Loader.

This skid-steer loader is designed with the finest **KIOTI** genuine components according to stringent quality standards set by the **KIOTI** quality assurance office. Information for proper operation of this Skid-Steer loader is based on advanced technologies and reliable data accumulated over several years.

Furthermore, the goal of this user manual is to help new owners familiarize themselves with the **SL750** skid-steer loader and to provide them with helpful information about the correct usage, safe operation, and maintenance of the skid-steer loader.

If the information you seek is not found in this manual or you need any help, your **KIOTI** dealer will be happy to help you. We are glad to be at your service.



< NOTE >

- Make sure to read this manual thoroughly and keep it handy for future reference.
- Also, in case of leasing or transferring this equipment to others, consider this manual part of the equipment and make sure to include it with the equipment.
- The specifications in this manual are subject to change without notice.

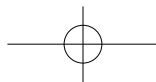
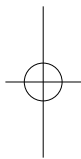
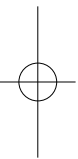
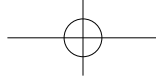
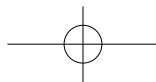
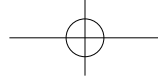



TABLE OF CONTENTS

■ FOR SAFE OPERATION.....	1
■ BEFORE OPERATION.....	2
■ SPECIFICATIONS.....	3
■ FUNCTION DESCRIPTION AND OPERATING TIPS.....	4
■ DRIVING INSTRUCTIONS.....	5
■ MAINTENANCE.....	6
■ STORAGE AND DISPOSAL.....	7
■ TROUBLESHOOTING.....	8
■ INDEX.....	9





CONTENTS

FOR SAFE OPERATION	1-1	DESCRIPTION.....	1-35
SAFETY PRECAUTIONS	1-2	CAUTIONS FOR DECAL MAINTENANCE	1-39
GENERAL PRECAUTIONS	1-2	BEFORE OPERATION.....	2-1
SERVICE, INSPECTION & MAINTENANCE	1-7	VEHICLE IDENTIFICATION NUMBER	2-2
SAFETY PRECAUTIONS WHILE OPERATING		PRODUCTION SERIAL NUMBER	2-2
THE MACHINE	1-13	ENGINE SERIAL NUMBER	2-2
STARTING THE ENGINE	1-13	ESSENTIAL REPLACEMENT PARTS.....	2-3
INSTALLING AND OPERATING ATTACHMENT	1-14	OILS AND FLUIDS.....	2-3
DRIVING.....	1-21	BELTS AND RUBBER PARTS	2-3
DRIVING ON ROADS.....	1-24	FILTERS	2-4
WHEN OPERATING ON SLOPES OR UNEVEN		OTHER COMPONENTS	2-4
TERRAIN.....	1-24	SPECIFICATIONS.....	3-1
LOADING AND UNLOADING A TRANSPORTING		SPECIFICATIONS.....	3-2
TRUCK	1-27	EXTERNAL DIMENSIONS.....	3-2
SAFETY PRECAUTIONS DURING THE STOR-		GENERAL SPECIFICATIONS	3-3
AGE OF THE MACHINE.....	1-29	OPTION LIST AND FEATURES	3-5
AFTER DAILY WORK IS COMPLETED.....	1-29	FUNCTION DESCRIPTION AND OPERAT-	
FOR LONG-TERM STORAGE.....	1-31	ING TIPS	4-1
SAFETY DECAL MAINTENANCE.....	1-33		
DECAL MOUNTING LOCATION	1-33		

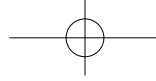

CONTENTS

EXTERIOR VIEW	4-3	INTERIOR LAMP SWITCH	4-17
SWITCHES	4-5	CONTROLS	4-18
MOUNTING LOCATION	4-5	RIGHT JOYSTICK CONTROL LEVER (LIFT ARM & BUCKET)	4-19
KEY SWITCH	4-7	LEFT JOYSTICK CONTROL LEVER (DRIVING).....	4-20
ENGINE ACCELERATION DIAL.....	4-8	HOW TO OPERATE EXTERNAL HYDRAULIC PRESSURE.....	4-23
HYDRAULIC UNLOCK SAFETY SWITCH	4-8	HOW TO OPERATE THE HIGH FLOW FUNCTION ..	4-24
PARKING SWITCH.....	4-9	14-PIN AUXILIARY POWER OUTLET	4-24
WORK LIGHTS SWITCH	4-9	HOW TO OPERATE THE AUXILIARY POWER	4-25
TURN SIGNAL LAMP SWITCH	4-10	THROTTLE PEDAL	4-26
SELF-LEVELING SWITCH (IF INSTALLED)	4-11	INSTRUMENT PANEL	4-26
WIPER/WASHER SWITCH (CABIN MODEL ONLY)..	4-11	INSTRUMENT PANEL FEATURES	4-26
HAZARD WARNING FLASHER SWITCH.....	4-12	TACHOMETER/HOUR METER	4-28
AUX (AUXILIARY HYDRAULICS) PORT SWITCH SWITCH	4-12	HYDRAULIC OIL TEMPERATURE GAUGE	4-28
HIGH FLOW SWITCH	4-13	FUEL GAUGE.....	4-28
HYDRAULIC LOCK SWITCH	4-14	ENGINE COOLANT TEMPERATURE GAUGE	4-29
HYDRAULIC QUICK ATTACH SYSTEM (IF IN- STALLED).....	4-14	MENU SWITCH.....	4-30
DPF REGENERATION SWITCH	4-15	LEFT/RIGHT MENU SWITCH/CAMERA SWITCH....	4-30
BEACON LAMP SWITCH (OPTIONAL).....	4-16	ENTER SWITCH.....	4-30
A/C SWITCH (CABIN MODEL ONLY)	4-17	ESC / BUZZER OFF BUTTON.....	4-31

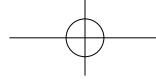

CONTENTS

HAZARD FLASHER.....	4-31	ANTENNA.....	4-54
ENGINE OIL PRESSURE WARNING LAMP	4-31	INTERIOR LAMP	4-54
ENGINE PRE-HEATING INDICATOR	4-32	ACCESSORIES.....	4-54
CHECK ENGINE WARNING LAMP.....	4-32	POWER SOCKET & USB SOCKET	4-54
DPF REGENERATION WARNING LAMP.....	4-33	RADIO & USB PLAYER (CABIN MODEL ONLY - OPTIONAL).....	4-55
DPF REGENERATION PROCESS INDICATOR	4-33	HEATER AND A/C (CABIN MODEL ONLY)	4-56
WATER-IN-FUEL WARNING LAMP	4-33	ADJUSTING THE SEAT	4-60
PARKING BRAKE LAMP	4-34	MCU (MACHINE CONTROL UNIT).....	4-62
SAFETY COVER WARNING LAMP	4-34	EMERGENCY EXIT	4-62
SAFETY BAR WARNING LAMP	4-35	MANUAL QUICK ATTACH SYSTEM	4-63
BATTERY CHARGE WARNING LAMP	4-35	REMOVING THE BUCKET (MANUAL TYPE)	4-63
REAR-VIEW CAMERA	4-36	INSTALLING AND REMOVING THE BUCKET (HY- DRAULIC QUICK ATTACH SYSTEM)	4-64
MAIN AND SUB-MENU	4-37	BOOM LOCK.....	4-64
MACHINE DIAGNOSIS	4-48	RELEASING THE LIFT ARM	4-66
CABIN & CANOPY.....	4-51	RAISING THE CANOPY AND CABIN	4-67
INTERIOR DEVICES (CABIN MODEL ONLY)	4-51	LOWERING THE CANOPY AND THE CABIN	4-68
EXTERIOR DEVICES.....	4-51	TIRES.....	4-69
DOOR (CABIN MODEL ONLY).....	4-52	TIRE INFLATION PRESSURE	4-70
DOOR STOPPER (CABIN MODEL ONLY).....	4-52	WHEEL TORQUE	4-70
WORK LAMP	4-52		
WIPER (CABIN MODEL ONLY).....	4-53		

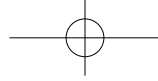

CONTENTS

DRIVING INSTRUCTIONS	5-1	FILLING THE BUCKET	5-16
PRE-OPERATION CHECK.....	5-2	DIGGING	5-17
INITIAL OPERATION.....	5-2	LEVELING	5-18
OPERATING THE ENGINE	5-3	FLOAT	5-18
STARTING ENGINE	5-3	DUMPING	5-19
STOPPING ENGINE.....	5-6	MAINTENANCE.....	6-1
WARMING UP	5-7	MAINTENANCE CHECK LIST.....	6-2
JUMP STARTING.....	5-7	DAILY CHECK ITEM.....	6-2
DRIVING AND OPERATION	5-8	MAINTENANCE SCHEDULE CHART.....	6-3
OPERATION BEFORE DRIVING	5-8	LUBRICANTS.....	6-5
FORWARD AND REVERSE DRIVING.....	5-10	MAINTENANCE CODE.....	6-6
TURNING	5-11	OPENING THE REAR DOOR.....	6-6
DRIVING ON SLOPES	5-11	CHECKING AND ADDING FUEL.....	6-6
PRECAUTIONS WHILE DRIVING ON THE ROAD ..	5-13	CHECKING ENGINE OIL LEVEL	6-7
LOADING AND UNLOADING THE MACHINE TO/ FROM A TRUCK.....	5-14	CHANGING ENGINE OIL AND REPLACING FILTER..	6-8
LIFTING THE MACHINE	5-15	CHECKING THE HYDRAULIC OIL LEVEL.....	6-10
OPERATION	5-16	REPLACING THE HYDRAULIC OIL AND FILTER.....	6-11
		CHECKING AND REPLACING CHAIN CASE OIL....	6-13
		CHECKING THE COOLANT LEVEL	6-13

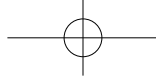

CONTENTS

CLEANING THE RADIATOR.....	6-14	SLOW BLOW FUSE	6-32
CHECKING GAUGES, METERS AND INDICATORS..	6-14	REPLACE THE BULB.....	6-33
CHECKING HEAD LIGHT, HAZARD LIGHT ETC.	6-14	REFRIGERANT INSPECTION	6-36
CHECKING SEAT BELT AND CABIN.....	6-14	STORAGE AND DISPOSAL.....	7-1
GREASING INSTRUCTIONS	6-15	STORAGE OF MACHINE	7-2
CHECKING WHEEL BOLT/NUT TORQUE	6-16	BEFORE STORAGE.....	7-2
FUEL FILTER	6-16	WHILE IN STORAGE	7-2
CLEANING AND REPLACING AIR CLEANER FIL- TER.....	6-17	AFTER STORAGE.....	7-3
CHECKING FUEL LINE.....	6-19	USAGE AND DISPOSAL.....	7-3
ADJUSTING FAN BELT TENSION	6-20	TROUBLESHOOTING	8-1
BATTERY.....	6-20	ENGINE TROUBLESHOOTING	8-2
BATTERY SHUT OFF SWITCH.....	6-21	MACHINE TROUBLESHOOTING	8-4
CHECKING INTAKE AIR LINE.....	6-23	ERROR CODE	8-5
CHECKING RADIATOR HOSE AND CLAMP	6-23	INDEX.....	9-2
FLUSHING COOLING SYSTEM AND CHANGING COOLANT	6-24		
ANTI-FREEZE.....	6-26		
BLEEDING FUEL SYSTEM	6-26		
CHECKING AND REPLACING WIPERS (CABIN MODEL ONLY).....	6-28		
BODY FUSE.....	6-30		



SAFETY AND VEHICLE DAMAGE WARNING

This manual includes information titled as DANGER, WARNING, CAUTION, IMPORTANT and NOTE. These titles indicate the following:



This symbol indicates the most serious hazardous situation which, if not observed, may result in death or serious injury.



This symbol indicates potentially hazardous situation which, if not observed, may result in minor or moderate injury. Also, this symbol can be used as a warning for unstable behavior.



This symbol indicates important procedures or information to perform work with more ease and skills.





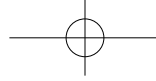

























This symbol indicates information useful to users.



UNIVERSAL SYMBOLS

In this manual, various symbols are used as guides for operation of your skid-steer loader. Below is a list of the universal symbols and their meanings.

	Auxiliary operation indicator		14-Pin C indicator		DPF Regeneration warning lamp
	Auxiliary hydraulic indicator		Ride control indicator		DPF Regeneration progress indicator
	Auxiliary electric port indicator		Hydraulic lock device indicator		Emission warning lamp
	High flow indicator		Quick attachment unlock warning lamp		Engine stop warning lamp
	2-speed indicator		Self-leveling indicator		Water-In-Fuel warning lamp
	Hazard warning lamp		Turn signal lamp		Parking Brake indicator
	Consumables management warning lamp		Engine oil pressure warning lamp		Tailgate safety cover warning lamp
	Fuel level warning lamp		Engine pre-heating indicator		Safety bar warning lamp
	Auxiliary hydraulic port M/F indicator		Check Engine warning lamp		Battery charge warning lamp
	Engine coolant warning lamp		Hydraulic oil temperature warning lamp		

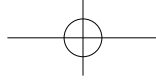

QUALITY ASSURANCE

KIOTI specializes in the design, manufacturing and distribution of safe and reliable commercial products. The high quality standards we set is to ensure the highest customer satisfaction possible for our customers.

Also, **KIOTI** maintains strict quality management that ranges from design to post purchase customer service. This program is constantly monitored and enhanced to best meet our customer's need. We follow many industry best practices and ISO, local, and international regulations and standards to produce the highest quality products.

KIOTI sets and tracks short and long term goals and metrics to achieve high quality standards. The director of quality management, on behalf of the CEO, is authorized and responsible for supervising effective execution of the quality management program and will take all appropriate actions to maintain the highest quality standards.

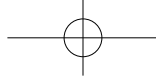

ENVIRONMENT PROTECTION

KIOTI specializes in the design, manufacturing and distribution of safe and reliable commercial products. **KIOTI** pursues environment-friendly operation by minimizing polluted factory waste, saving resources and following its own regulations, including environmental laws and ISO 14001;1996 requirements.

Also, **KIOTI** is responsible for achieving its own environmental goals to contribute to the protection of the environment. These goals are announced to the public to let the general public and stakeholders understand our commitment to the environment. The environment protection system should be fully understood by all employees and it is reviewed periodically for its effective execution to take appropriate actions accordingly.

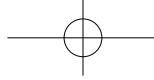

PRODUCT SAFETY MANAGEMENT SYSTEM

KIOTI strives to design, manufacture and supply safe products to customers as well as quality service for ultimate satisfaction. To achieve this, our employees are committed to fully understanding the product safety management system and following the corresponding laws and standards.

The director of service, on behalf of the CEO, is authorized and responsible for supervising effective execution of the product safety management system periodically and taking appropriate actions accordingly.



SAFETY AND PUBLIC HEALTH POLICY

As **KIOTI** specializes in the design, manufacturing and distribution of safe and reliable commercial products, it proactively reviews hazardous and dangerous factors that can occur during manufacturing to prevent any possible incidents. Also, it runs its own safety and public health management system to promote an accident-free business workplace. **KIOTI** is dedicated to following the applicable safety and public health regulations, including OHSAS18001;1999, as well as its own internal safety and public health goals.

These goals are announced to the public to let all employees and stakeholders understand our commitment to the safety and public health. This safety and public health management system should be fully understood by all employees and it is reviewed periodically for its effective execution to take appropriate actions accordingly.

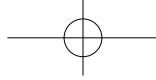

GUIDANCE FOR "USE AND DISPOSAL" OF RESOURCES FOR PROTECTION OF ENVIRONMENT

As **KIOTI** specializes in the design, manufacturing and distribution of safe and reliable commercial products, it proactively reviews hazardous and dangerous factors that can occur during manufacturing to prevent any possible incidents., it runs its whole business environmentally friendly through minimizing pollutants and saving resources as much as possible. All employees are responsible for following the environmental laws and related regulations and improving their involvement to contribute to protection of the environment. To achieve this, performance of **KIOTI**'s own environmental protection goals are measured periodically and related information is available to customers and stakeholders to ensure transparency of its environmental management system.

Be more active in protecting our environment by following guidance for "use and disposal" of resources below:

1. Users of this product should read and understand this manual thoroughly and avoid overload to protect the environment.
If this product is overloaded, its life can be shortened and unburned exhaust gas can pollute the environment.
2. When changing various fluid, such as engine oil, transmission fluid and hydraulic oil, never dispose used fluid carelessly.
It can pollute the ground and water seriously. Hand used fluid to your dealer to dispose of it according to the applicable laws.
3. Handle and operate this product in a proper manner. If it is expired, never abandon (dispose) it in any place. Rust, oil, etc. leaked from waste product improperly stored can pollute the ground and water. Therefore, when disposing an expired product, have it collected by an authorized scrap dealer to dispose of it according to the applicable laws and regulations.

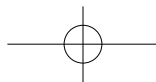
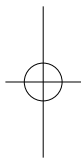
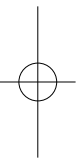
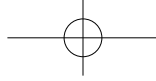



FOR SAFE OPERATION

SAFETY PRECAUTIONS	1-2
GENERAL PRECAUTIONS	1-2
SERVICE, INSPECTION & MAINTENANCE	1-7
SAFETY PRECAUTIONS WHILE OPERATING THE MACHINE	1-13
STARTING THE ENGINE	1-13
INSTALLING AND OPERATING ATTACHMENT	1-14
DRIVING	1-21
DRIVING ON ROADS	1-23
WHEN OPERATING ON SLOPES OR UNEVEN TERRAIN....	1-24
LOADING AND UNLOADING A TRANSPORTING TRUCK....	1-27
SAFETY PRECAUTIONS DURING THE STOR- AGE OF THE MACHINE	1-28
AFTER DAILY WORK IS COMPLETED	1-28
FOR LONG-TERM STORAGE	1-31
SAFETY DECAL MAINTENANCE	1-33
DECAL MOUNTING LOCATION	1-33
DESCRIPTION	1-35
CAUTIONS FOR DECAL MAINTENANCE	1-39

1

1



SAFETY PRECAUTIONS GENERAL PRECAUTIONS

The following information contains general and safety related precautions regarding the operation and maintenance of the machine. When you see the words CAUTION, WARNING or DANGER, please read and follow the recommended guidelines carefully to prevent incidents that could lead to injury to the operator or bystanders or damage to the machine or property.

Always read this manual carefully before operating the machine to ensure safe operating practices and preventative measures are followed. Always follow the recommend safe operating procedures when operating the machine. Always read, understand and follow the information provided in all safety decals applied to the machine.

Failure to follow the information outlined in this manual, warning decals on the machine and recommended safe operating practices could lead to machine or property damage, injury or death to the operator or others.

Always follow all safety precautions and safe operating procedures as out-

lined in this manual and all decals on the machine for your safety and the safety of others

The following individuals should not be allowed to operate this machine under any circumstances.

- Individuals under the influence of alcohol or drugs
- Pregnant women
- Individuals who do not possess a valid driver's license
- Individuals who have not read and understand this owner's manual
- Individuals who have not been trained on the safe operation of this machine

NOTE

- Allowable age and qualification of operators should be followed by the related laws of local area where the machines are purchased in.

RECOMMENDED ATTIRE WHEN OPERATING OR WORKING ON THIS MACHINE

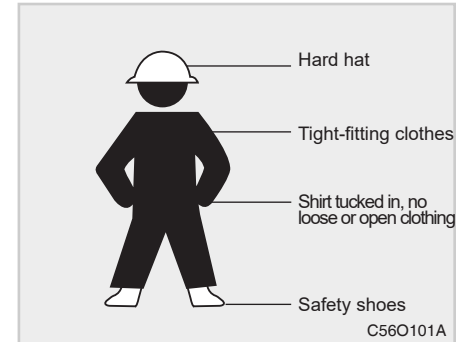

Please wear the appropriate working clothes.

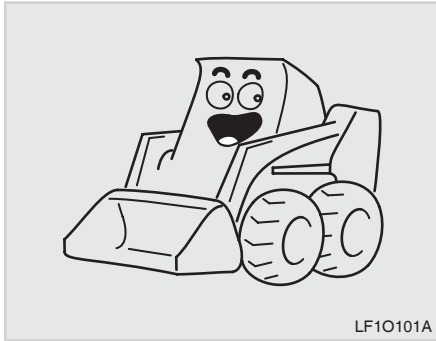

This machine is designed for use in most agricultural or construction type settings where a "skid-steer" type machine would be utilized to push, lift, dig, grade or power hydraulic implements to complete daily tasks.

The manufacturer is not liable for any damage resulting from unauthorized use, unauthorized or unapproved use which could potentially lead to unsafe conditions for an operator or bystanders. Authorized use means complying with operation, service

and repair standards set by the manufacturer as outlined in this owner's manual and the numerous warning decals placed on the machine.

This machine should only be operated by skilled individuals who have read and understand this owner's manual on the safe operation of the machine.

Operators should follow any state or local accident prevention protocols, general health and safety standards and traffic regulations.

The manufacturer is not liable for any damage resulting from unauthorized modification.

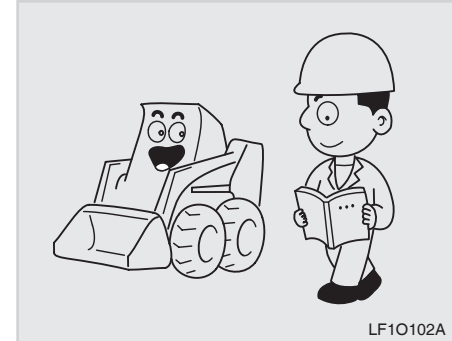

1

Make sure the owner's manual accompanies the machine should the ownership be transferred, leased or rented. Without the owner's manual, operators may not familiarize themselves with the safe operating practices of this machine.

The manufacturer is not liable for the transfer of the owner's manual to subsequent owner's nor for situations that could be avoided through the safe operation of the machine as outlined in this manual.

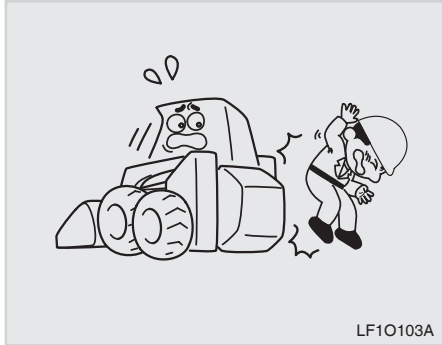

LF1O103A

Do not let anyone come close to the machine while working.

Otherwise, it can lead to a personal injury.

Keep bystanders a minimum of 50 feet away from the operating area while the machine is in use or under repair.

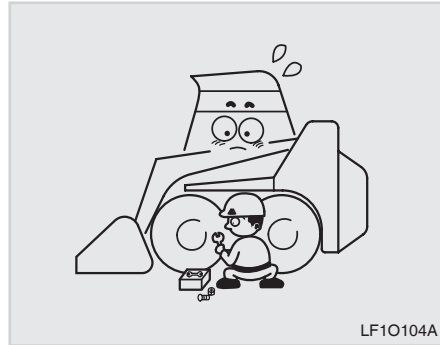

LF1O104A

Do not modify the machine.

Modifying the machine could lead to premature wear or machine failure, damage to property or create an unsafe machine or work environment.

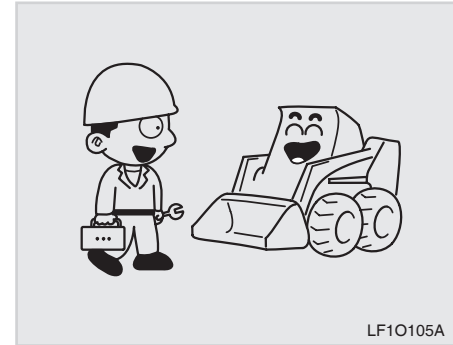

LF1O105A

Check the condition of the machine before and after each operation use. Repair it immediately as necessary. Repair or replace any broken or damaged items immediately.

Otherwise, an unexpected accident may happen due to poor maintenance. Follow the recommended guidelines daily, weekly or hourly inspection and maintenance as outlined in this manual to ensure your machine remains safe and ready to work.

Please contact your Authorized **KIOTI** Dealer to schedule maintenance or repairs as needed.

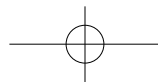



When starting the engine in an enclosed space, ventilate the area by opening doors or windows and remove the machine from the enclosed space to an open air area.

- Do not idle or run the engine in a poorly ventilated area.

Otherwise, you may be poisoned by exhaust fumes, which may cause brain damage due to lack of oxygen or even death.

- Operating the machine in enclosed or poorly ventilated areas could lead to Carbon Monoxide poisoning or even death.

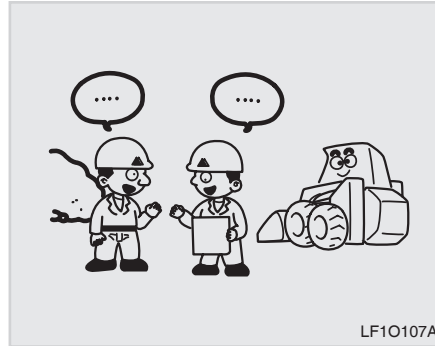

Before operating the machine, be sure to inspect the work area carefully for any hazards or items that could cause injury or accidents. Always understand the details of the job or work to be performed and discuss any concerns prior to beginning work.

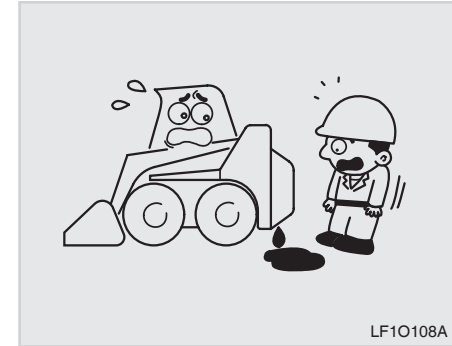

Check for any leakage of engine oil, hydraulic oil, fuel, or coolant to prevent damage to the machine, danger to the operator and reduce the risk for fire or other potentially dangerous situations.



Keep fire extinguishers and emergency kits handy in preparation of fire or emergency situations.

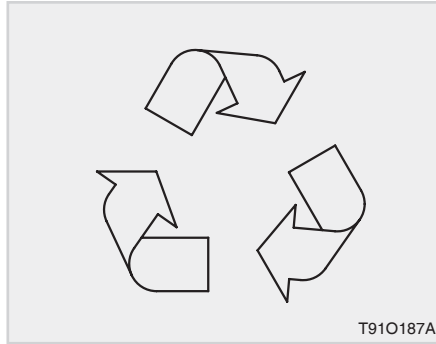

Careless disposal of waste product can be harmful to environment and ecosystem. There are various types of hazardous wastes produced from the machine, including oil, fuel, coolant, brake fluid, filter, battery and etc. Drain fluids in a leak proof container designed for the handling and disposal of automotive and industrial fluids. Never drain or store fluids in food or beverage containers. Always dispose of fluids or recycle through approved methods in your

state or region. Never pour fluids on the ground, into rivers or drains, etc. A/C refrigerant is harmful to the atmosphere and should be stored and disposed of through approved methods in your state or region. Never release refrigerant into the atmosphere.

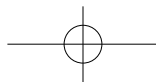



SERVICE, INSPECTION & MAINTENANCE

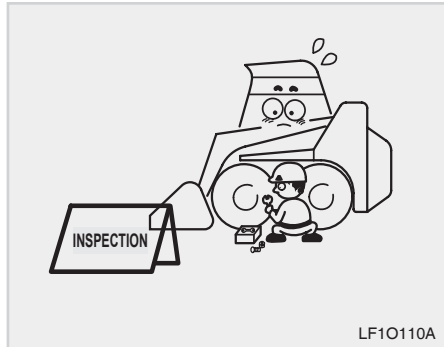

When servicing, repairing or cleaning the machine, park the machine on level ground, lower the lift arm and attachment to the ground, apply the parking brake, turn the engine off and remove the key before performing any work.

While servicing the machine, it is recommended to tag the machine alerting others that it is undergoing maintenance or repairs.



Before fueling, park the machine on level ground, lower the lift arm and attachment to the ground, apply the parking brake, turn the engine off and remove the key. **NEVER** add fuel while the engine is running. Always keep flammable items such as lighters, cigarettes, etc. away from the machine. After refueling, install the fuel filler cap and wipe up any spilled fuel.

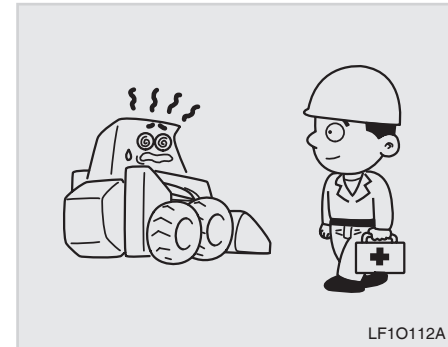

In the event the machine breaks down or fails to operate correctly, stop the machine immediately, place the lift arm and attachment on the ground, engage the park brake, turn the engine off and remove the key.

Consult with your Authorized **KIOTI** Dealer on the diagnosis and repair of the machine.



LF1O113A

Leaking fluids, oil or grease could be dangerous or cause a fire. Be sure to keep the machine clean and free of leaks.



LF1O114A

Never open the radiator cap while the radiator is hot.

- Stop the engine and let the engine cool down before opening the radiator cap.
- Check the coolant in the reservoir tank.

Opening the cap on a hot radiator could cause steam or coolant to release under pressure which could be a burn hazard!



LF1O115A

Always dispose of fluids in an approved container and follow local, state or territorial laws on the proper handling and disposal of fluids.

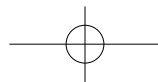

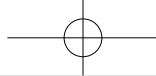

Be sure to keep cigarettes, items that may spark or open flames away from the battery at all times. When charging the battery, be sure to use a charger rated for the correct voltage, match the cables to the correct terminals (do not reverse the polarity) and keep the battery in an open area to allow any gases to vent to the atmosphere. Failure to follow these guidelines could cause the battery to explode.

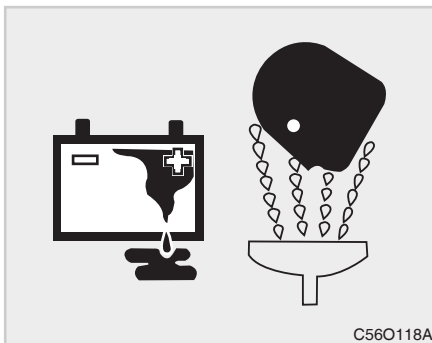

BATTERY ACID CAN BURN!

Be careful not to spill battery fluid onto your body or clothes. If battery fluid gets onto your eyes, skin, clothes or tool, rinse it immediately with water thoroughly. If it got into your eyes or onto your skin, rinse the affected area thoroughly with water and seek medical attention immediately. Should battery fluid get onto your clothes or tools, rinse immediately with water thoroughly.

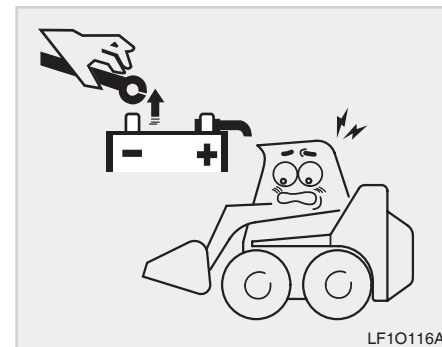

1

When disconnecting the battery, disconnect to the negative cable first. When connecting it, connect to the positive cable first.

- Be sure to use the specified battery only.
- Do not reverse the positive and negative battery cables.

Otherwise, a short circuit can cause a burn or fire.

The following symptoms may indicate a discharged battery.

- The starter motor will not engage or will not rotate making it impossible to start the engine.
- The headlights are much dimmer than usual.
- The horn won't sound or sounds weak.

Remove the key from the ignition and rotate the battery switch to the "OFF" position to prevent battery discharge when the machine is not in operation.

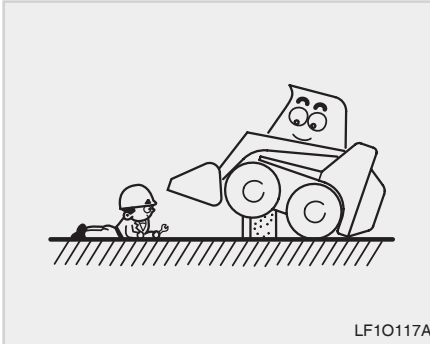

CRUSH HAZARD

When inspecting, servicing or performing repairs to the underside of the machine or the drive system, never rely on the machine's hydraulic system as the only means of raising or holding a portion or all of the machine off the ground. Always utilize jack stands, safety blocks or other approved safety devices to secure the machine in place and prevent accidental fall, settling or lowering of the machine.

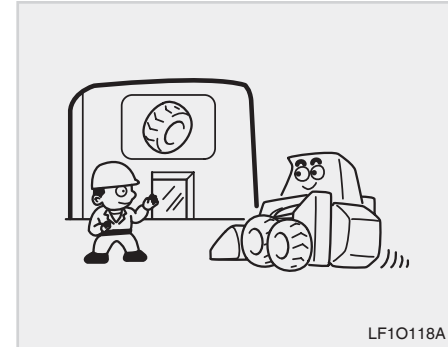

Maintain the tire inflation pressure as specified in the user's manual. Replace damaged tires or tires with worn lugs or no tread before operating the machine. Contact your local Authorized **KIOTI** Dealer or local tire dealer for assistance with tire repair or replacement.

- Underinflation can cause sidewall damage or a tire to slide off the rim under load or when turning leading to loss of control, loss or damage to the load or machine rollover.



- Over inflation can cause the tire to rupture leading to loss of control, loss or damage to the load or machine rollover.

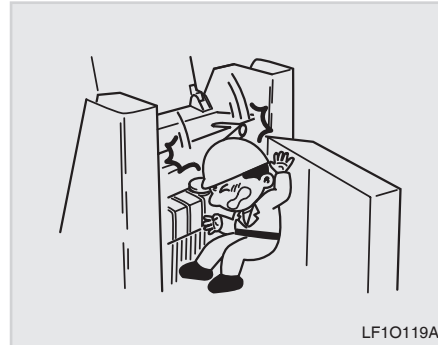

Use caution when opening inspecting or closing the rear door or other portions of the engine bay to prevent making contact with hot, heavy or potentially moving parts that could cause injury.

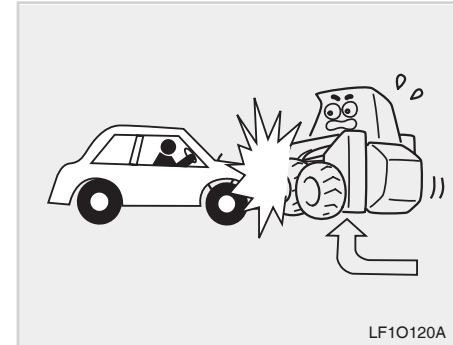

Inspect all safety features prior to operation of the machine to minimize risk of injury in the event of an accident. Safety features of this machine include: ROPS, seatbelt, operator restraint bars, park and hydraulic lock functions, horn, headlight, safety and signal lamps, all safety switches and warning decals, optional fire extinguisher, rear door and front door (cab models).



To prevent slips and falls entering or exiting the machine, replace the treads or the anti-skid steps if they are worn out or no longer function normally.

Otherwise, it can lead to injuries.

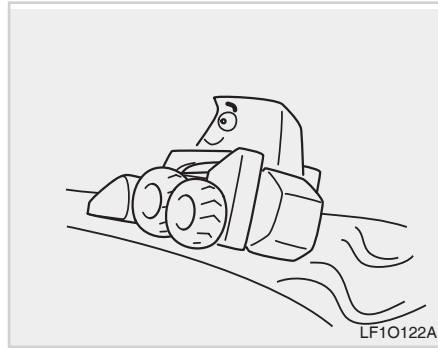

Check the wheels and lug nuts daily to ensure they are tight. Normal driving could be impacted if the wheels are not tight or lead to an accident or machine damage.



Always install any covers, shields or brackets removed during maintenance or repair before operating the machine. Failure to do so could lead to machine damage or personal injury.

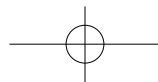

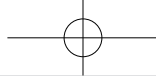

SAFETY PRECAUTIONS WHILE OPERATING THE MACHINE STARTING THE ENGINE



Do not try to repair or inspect the fuel system (fuel injection pump, fuel injection nozzle, etc.), or hydraulic pump/hydraulic system by yourself. Always return your machine to your Authorized **KIOTI** Dealer for inspection, diagnosis or repair. Attempting to make repairs to these systems without proper training could lead to injury, significant component failure or machine damage.

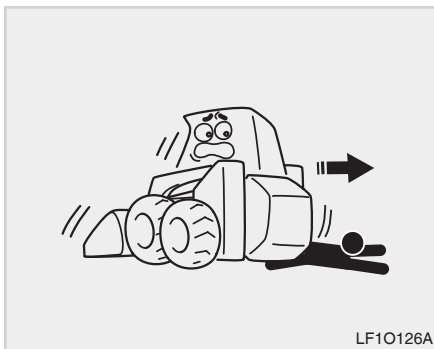

Always survey the surrounding area for bystanders, co-workers or hazards within the work area. **NEVER** start the machine with people next to the machine, in the general working area or before reviewing and addressing any hazards within the working area. **NEVER** attempt to start the machine with the rear door open or shields, covers, or brackets removed or safety features removed.



Exhaust components including the exhaust pipe and muffler can become extremely hot during use. To prevent injury or burns, **NEVER** touch any of the exhaust components while the engine is running or without allowing sufficient time for cool down after use.

INSTALLING AND OPERATING ATTACHMENT



LF1O128A

To prevent injury or machine damage, **NEVER** open the rear door or hood to access the engine area while the engine is running.

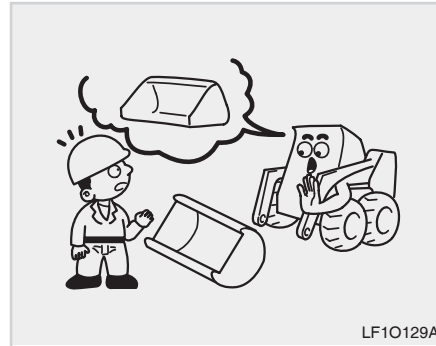

LF1O129A

Only use implements designed and manufactured in accordance with SAE J2513 or ISO 24410 specifically for skid steer or compact track loader use.

Implements not designed and manufactured in accordance with SAE J2513 or ISO 24410 or for use with other types of equipment could cause machine damage or fail to properly connect and/or operate correctly with this machine.

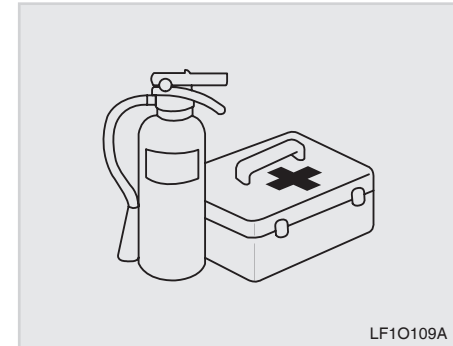

LF1O109A

Always wear your seat belt and keep the operator restraint bars in the down position when operating the machine to prevent injury, especially in the event of a machine roll-over.



Before driving or operating the machine, it is the operator's responsibility to read and fully understand the owner's manual and all safety decals. Prior to machine operation, confirm all safety features are installed and operating correctly.

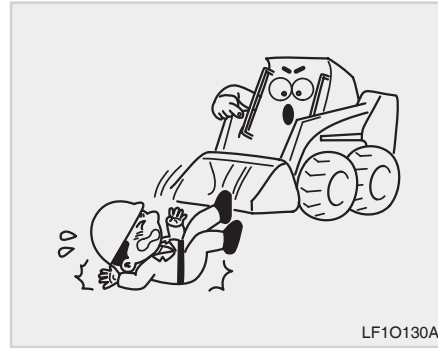

Use the safety handles and steps when getting on or off the machine. **NEVER** attempt to jump on or off the machine without using the handles and steps.

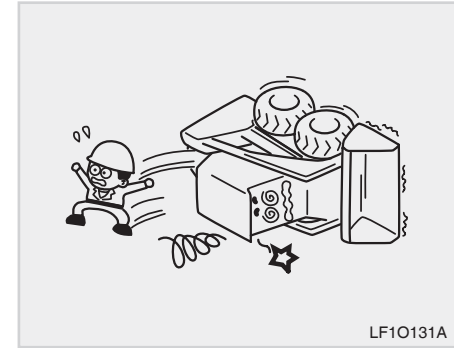

This machine is equipped with a removable rear glass. In the event of a machine roll-over or other incident causing the door to be blocked, damaged or inoperable for exit, follow the directions for rear glass removal to safely exit the machine.



Inspect the machine daily for loose, damaged or missing hardware or other items before use.



Always survey the surrounding area for bystanders, co-workers or hazards within the work area. **NEVER** start the machine with people next to the machine, in the general working area or before reviewing and addressing any hazards within the working area.

For high traffic areas, it may be necessary to designate a safety person or someone who can coordinate personnel and machine traffic safely and without risk to people, property or equipment.

NEVER place your hands or head outside the machine or attempt to leave the driver's seat while the machine is in operation.

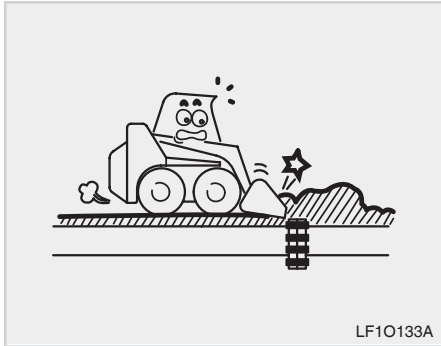

When working on a site with underground utilities or suspected underground utilities (electric, gas, water, sewer, etc), or work is being performed near underground utilities, always contact the local utilities locating service before performing any work. Failure to locate utilities prior to beginning work could lead to injury or machine or property damage.

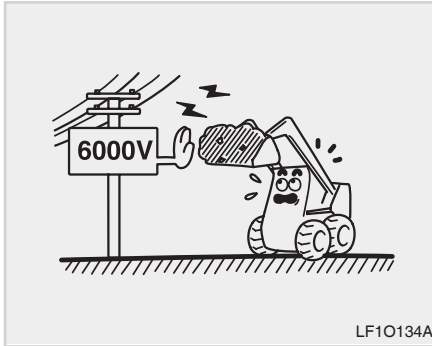

Working near overhead power lines is extremely dangerous. Maintain a minimum of 15 feet from any overhead power line to minimize the risk for injury or machine damage due to electric shock.

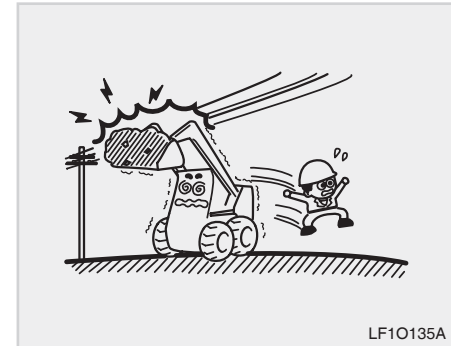

Should you make contact with a live electrical wire, shut the machine down, dial 9-1-1 for emergency help immediately and remain calm.

Leaving the operator station while the machine is in contact with a live electrical wire could cause severe burns or electrocution. NEVER leave the operator's station for any reason until emergency personnel have verbally cleared you to leave the machine.



Always survey the surrounding area for bystanders, co-workers or hazards within the work area.

When working in an area with multiple obstacles or hazards, pay extra attention, especially when turning or backing to try and avoid bringing the machine into contact with the obstructions or hazards to minimize risk for injury or damage to the machine.

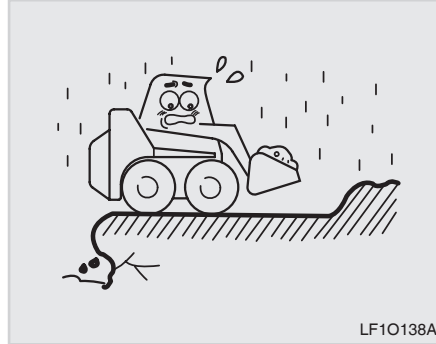

Avoid working near steep drop offs or areas where the ground may be unstable and is likely to slide, sink or suddenly drop in elevation. Heavy rains, extremely wet conditions or areas that have undergone excessive grading may become weak or be more susceptible to experience these conditions which could lead to injury, machine damage or become at high risk for machine roll-over.



This machine is designed for pushing, lifting, excavating and powering optional hydraulically driven attachments. Operation of this machine for work or duties outside of it's intended scope could lead to injury or machine damage.

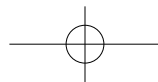



1

Always drive slowly when operating the machine in reverse, through turns or over uneven, rough or unstable terrain. Use special attention when carrying loads in addition to operating the machine through these types of obstacles and remember these important points:

- Keep attachment or loads low, close to the ground to maintain a stable, low-center of gravity.
- Driving too fast or having a load shift or move could lead to injury due to machine damage or machine roll-over.

When operating the machine in low light conditions, turn the front and rear work lights on to improve forward and rearward visibility. If additional light is needed inside the cabin, the interior dome lamp can be turned on for additional illumination and improved interior visibility.

Should visibility reach a point that the operator can't clearly see a minimum of 10 feet around the machine in all directions, it is recommended to cease operations till visibility improves. Operating under conditions that impair visibility in the working area around the machine could lead to injury or machine damage.

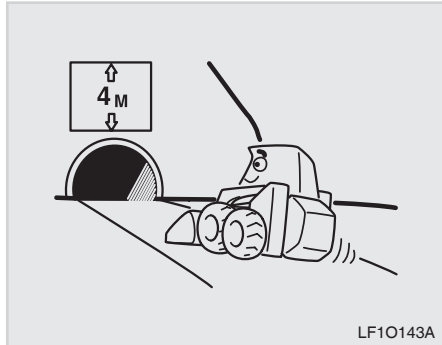

Utilize extreme caution when operating the machine in confined spaces, especially those with limited overhead clearance such as tunnels, overpasses etc. to prevent injury, machine or property damage.

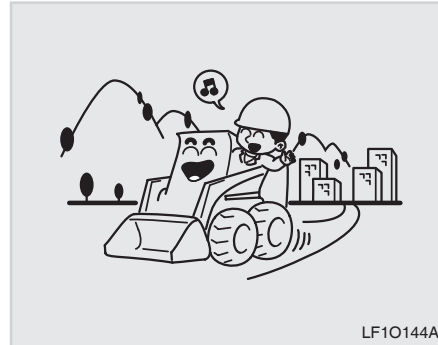

It is the operator's responsibility to read and fully understand the owner's manual and all safety decals. Prior to machine operation, confirm all safety features are installed and operating correctly.

Always comply with all local, state and federal guidelines and requirements and only operate the machine under safe working conditions.

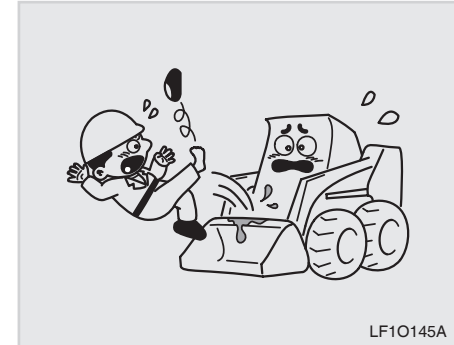

Use the safety handles and steps when getting on or off the machine. NEVER attempt to jump on or off the machine without using the handles and steps.

Always keep the handles and steps clean and free of grease or fluids, mud and debris to minimize the risk for slipping, falls or injury.

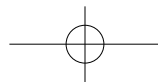



DRIVING

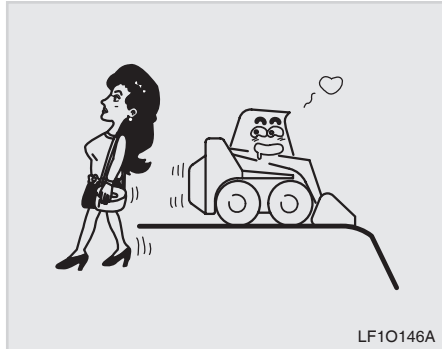

Always focus on the safe operation of the machine and **NEVER** operate the machine if you are distracted, disoriented or under the influence of alcohol or drugs.

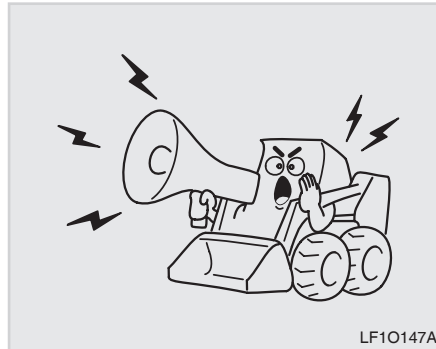

Always sound the horn to alert others that the machine is going into motion before starting to perform any work or travel.

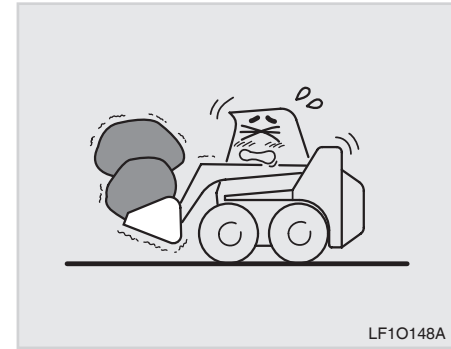

Overloading the machine could lead to injury, machine or property damage. Always operate the machine within the safe working load limits outlined in this manual. Always keep loads low to the ground and avoid sudden starts, stops or turns to maintain a low and stable center of gravity to prevent risk of machine roll-over.

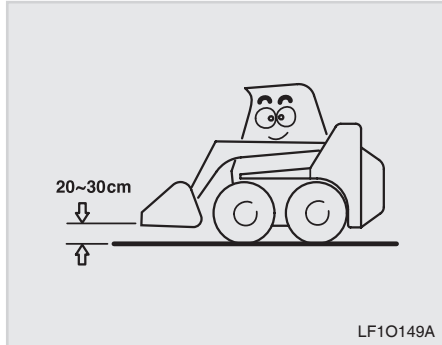

When operating on public roads or highways, always keep loads low to the ground but not too low to make contact with the road. Avoid sudden starts, stops or turns to maintain a low and stable center of gravity to prevent risk of machine roll-over.

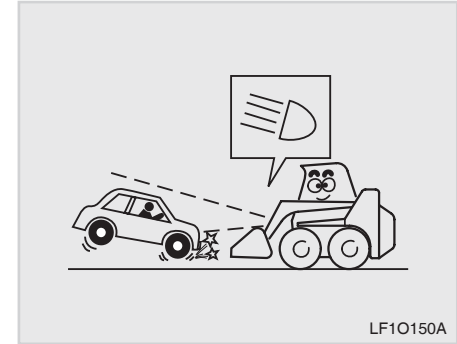

Only operate this machine on public roads or highways if absolutely necessary. Always turn working lights and hazard lights on before entering the roadway to improve visibility and alert others to the machine's presence. If possible, utilize a spotter or pilot vehicle to alert others of the machine's presence.

Always turn on the working lights when operating the machine at night or in low-light conditions.

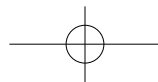



In the event of a machine breakdown or malfunction while operating on a public road or highway:

- Move the machine to the side of the road, out of the way of traffic.
- On a 2 lane road, place a safety triangle or flare 50 feet in front of the machine, 50 feet behind the machine and 100 feet behind the machine to alert others of the machine's presence on the side of the highway.

- On a divided highway, place a safety triangle or flare 50 feet behind the machine, 100 feet behind the machine and 200 feet behind the machine to alert others of the machine's presence on the side of the highway.

DRIVING ON ROADS

- Follow all traffic rules.
- Avoid driving at night. If it is inevitable, turn on the front and rear work lights and flashers (hazard warning signals) to prevent an accident.
- When driving on a road, do not make sudden movements like stopping or turning and stay in the lane furthest to the right whenever possible and stay on a low-speed lane.
- In case of machine failure: Move the machine to the side of the road, out of the way of traffic and follow the recommended guidelines in this manual for warning alerts to on-coming drivers.

1



WHEN OPERATING ON SLOPES OR UNEVEN TERRAIN

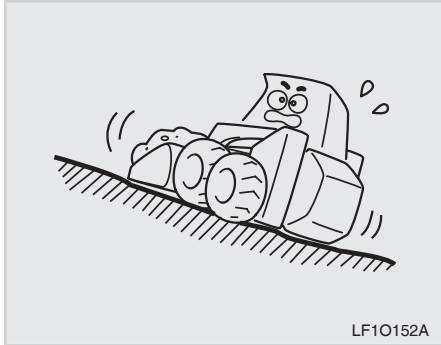

This machine is designed and engineered to operate on a maximum slope of 10° (10 degrees).

Working on slopes can be extremely dangerous. When working on slopes too steep for the safe operation of the machine, loss of load, loss of control or roll-over could occur leading to injury, machine or property damage.

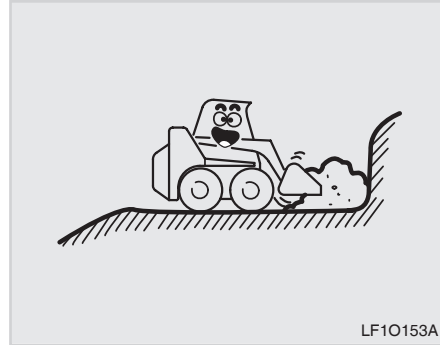

If working on a slope is inevitable, grade the slope as much as possible before beginning work to reduce the risk of loss of control or roll-over. **UNDER NO CIRCUMSTANCES**, should you attempt to work on a slope greater than 10° (10 degrees).

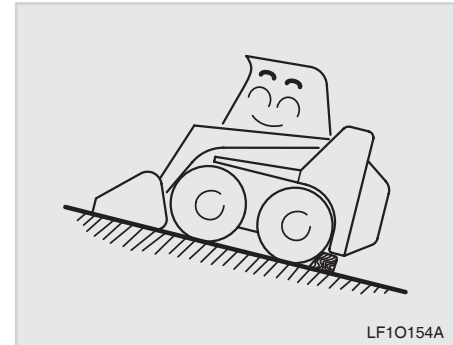

Never stop or park the machine on a slope, exit the operator station and leave the machine unattended. An unattended machine could roll or slide and cause injury, machine or property damage.

Should you need to leave the operator station while the machine is on a slope, always lower the bucket to the ground, engage the park, turn the engine off and remove the key from the ignition. **ALWAYS** chock the wheels or tracks to prevent an accidental machine slide or runaway.

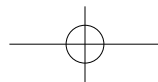

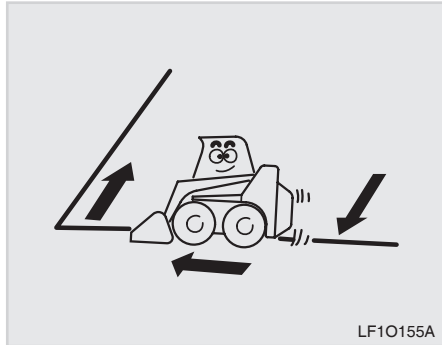

Never operate the machine sideways or across the slope. Always travel up or down the slope to prevent machine roll-over.

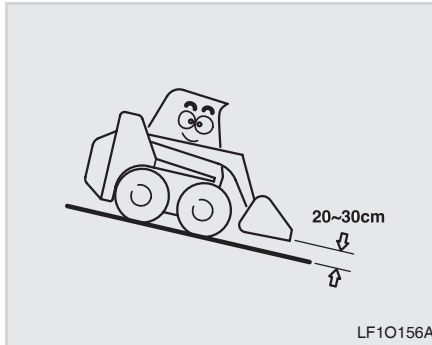

Driving on a slope is dangerous. When driving downhill follow these guidelines:

- Always drive or back slowly downhill.
- If driving downhill, always keep the bucket as close to the ground as possible but never higher than 8" (8 inches) to prevent the machine from tipping.
- If carrying a load, it is recommended to back down the slope, keeping the load uphill.

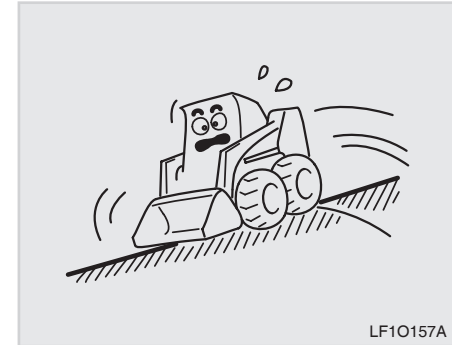

Turning while driving on a slope is dangerous. Avoid turning on a slope unless absolutely necessary. If you must turn on a slope be sure to:

- Always keep the load facing uphill to maintain stability and control
- Keep the load close to the ground to maintain a low and stable center of gravity
- Avoid turning on loose or soft soil that could collapse or slide



- Slow down and make turns cautiously and carefully. Avoid sudden, abrupt or quick movements that could cause the machine to become unstable
- Only turn if absolutely necessary

Always use caution when working on slopes. Working on slopes can be extremely dangerous. When working on slopes too steep for the safe operation of the machine, loss of load, loss of control or roll-over could occur leading to injury, machine or property damage.

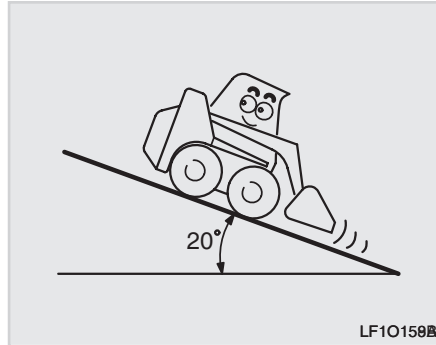

This machine is designed and engineered to operate on a maximum slope of 20° (20 degrees). Working on slopes greater than 20° (20 degrees) could cause engine damage due to lack of lubrication on internal parts.

Working on slopes can be extremely dangerous. When working on slopes too steep for the safe operation of the machine, loss of load, loss of control or roll-over could occur leading to injury, machine or property damage.



Always use caution when driving on dirt paths or areas that have recently been excavated or graded. Loose or soft soils can collapse or slide leading to loss of control or stability resulting in potential machine or property damage or injury.

- Do not drive on a soft edge of a road or a grass-covered shoulder.
- Drive at a low speed with care when it is raining or after rain.

Otherwise, the edges can collapse and the machine can roll over. Leading to damage to machine or property or injury.

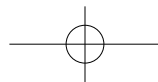



LOADING AND UNLOADING A TRANSPORTING TRUCK



Always drive at slow speeds under the following conditions:

- rough or uneven terrain
- slopes
- curves or terrain with a lot of twists and turns
- Soft soils or muddy conditions where loss of control could occur
- When carrying a load
- When operating the machine in conditions where operator visibility is impaired

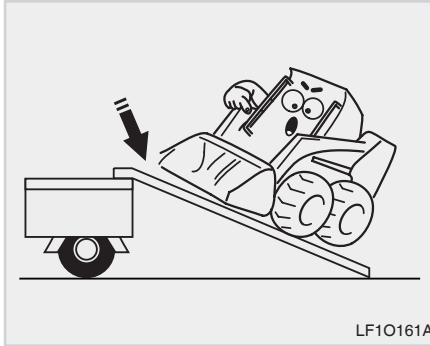

When loading or unloading the machine on a transport vehicle:

- Only load onto trailers or trucks designed to haul heavy equipment with a load carrying capacity rated to handle the machine + attachments.
- Never attempt to load onto a trailer or truck with ramps that are not permanently affixed or designed to be pinned or locked to the trailer or truck bed for loading/unloading.

- Never attempt to load or unload on smooth ramps. Always use ramps with traction plates
- Ramps must be a minimum of 12" wider than the width of the tires/tracks on the machine to minimize the risk of run-off during loading/unloading
- Ramps should be a minimum of twice as long as the height of the cargo bed to minimize the approach angle. Never attempt to load onto a trailer or truck with an approach angle exceeding 10° (10 degrees)
- Always travel slowly and cautiously when loading/unloading
- Always keep the load uphill
- Always properly secure the machine to the transport vehicle with chains utilizing the securing points designed into the machine



LF1O162A

Always align the ramps with the center of both the left and right treads before loading/unloading the machine. Always approach the ramps and move slowly. Never try to turn or re-align the machine while on the ramps. During loading/unloading should the machine not align correctly with the ramps, return to the starting position, align the machine correctly and resume.

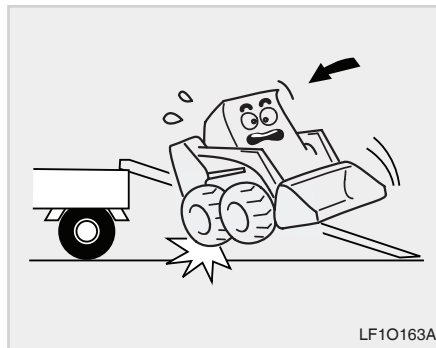

LF1O163A

Always keep the load uphill. If loading the machine with an attachment, drive up the ramps to load and back down to unload.

If loading the machine without an attachment, back the machine up the ramps to load and drive down to unload.

SAFETY PRECAUTIONS DURING THE STORAGE OF THE MACHINE AFTER DAILY WORK IS COMPLETED



LF1O165A

At the end of each work day/shift, be sure to park the machine on a flat, level surface, lower the attachment to the ground, apply the park brake, turn the engine off and remove the key before exiting the cab.

Inspect the machine for damage, loose hardware, leaks, etc. During the inspection, be sure to remove any debris or foreign material from the intake, radiator screens or engine area to reduce the risk of overheating or fires.



Also remove any mud or foreign debris from the undercarriage and belly of the machine if applicable to extend the life expectancy of the machine.

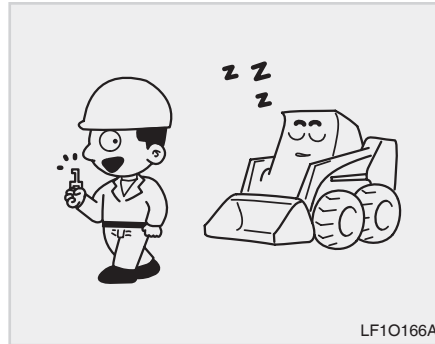

When preparing the machine for overnight storage, be sure to lock the cab (if applicable) and chock the wheels/track to prevent accidental movement.

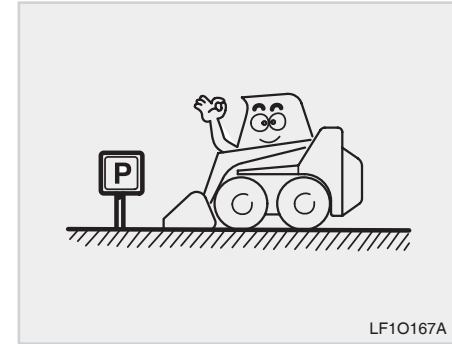

Never store or park the machine in an area where damage is likely to occur. Examples of improper storage or parking locations include:

- Low-lying areas near creeks or streams that are susceptible to frequent flooding.
- Areas near moving or working equipment.
- Areas prone to falling debris.
- Recently graded areas with soft or loose soil likely to slide or settle.



- On slopes or inclines where the machine is likely to slide or roll.
- On the side of a street or highway.

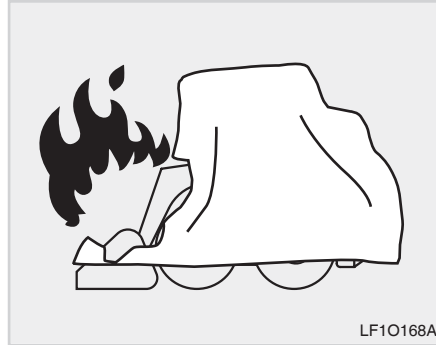

If covering the machine, be sure to allow the machine, including the engine and exhaust to cool before applying the cover. Applying a cover to a hot machine could ignite a fire causing injury or damage to machine or property.

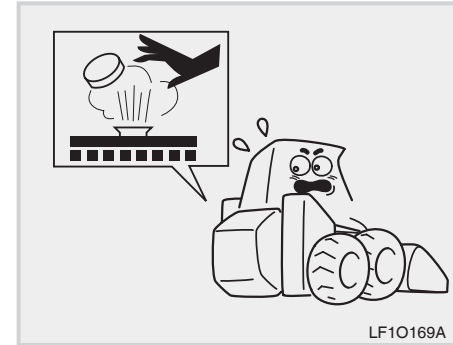

Never open the radiator cap while the radiator is hot.

- Stop the engine and let the engine cool down before opening the radiator cap.
- Check the coolant in the reservoir tank.

Otherwise, Hot liquids and steam can cause burns!

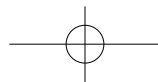



FOR LONG-TERM STORAGE



Always store the machine on a flat, level surface with the attachment lowered to the ground, the park engaged, ignition key removed, wheels/tracks chocked and cabin door locked (if applicable). For long-term storage:

- Always inflate the tires (if applicable) to maximum pressure.
- Always remove any debris, mud or foreign material from the machine.
- Fill the fuel tank with clean fuel and add a fuel stabilizer to prevent moisture build up due to condensation.
- Fill the hydraulic reservoir to the recommended operating level to minimize moisture build up due to condensation.
- Inspect the machine for loose hardware, leaks or damage that requires repair prior to storage.
- Turn the battery switch to the "off" position. For storage of more than 30 days, it's recommended to remove the battery from the machine or disconnect the negative cable.

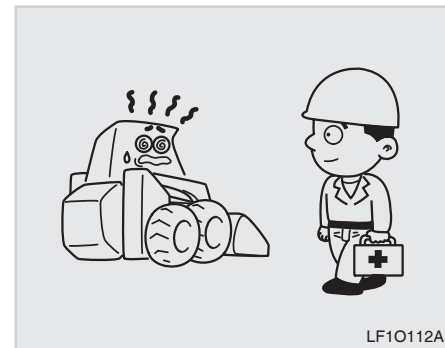

1

Perform all repairs when issues arise to minimize risk of injury, machine or property damage due to a malfunctioning machine. For repairs under warranty or beyond your skill set, always contact your Authorized **KIOTI** Dealer for assistance.

Small items left unattended become costly and expensive repairs over time. Addressing items quickly saves time, money and reduces the risk for injury or machine or property damage.



LF1O105A

Always follow the recommended maintenance schedule to keep your machine operating efficiently.

Only use genuine **KIOTI** replacement parts for maintenance and repairs to ensure the correct fit and performance are achieved over the life expectancy of your machine.

Maintain records of all maintenance and repairs performed.

Follow local, state/territorial and federal/provincial guidelines for the proper disposal of fluids or parts.

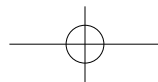



SAFETY DECAL MAINTENANCE DECAL MOUNTING LOCATION

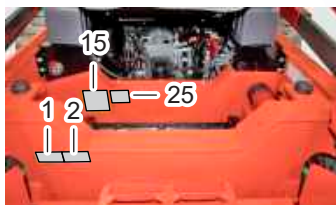
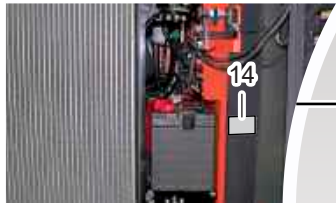
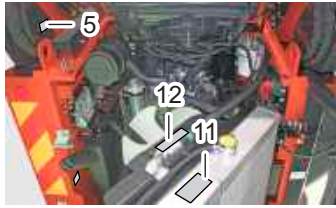

LF10172B

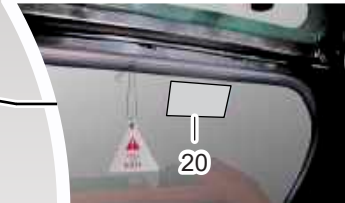

1



LF10174B



DESCRIPTION

(1) Part number: LF14-1503A



(2) Part number: LF14-1501A

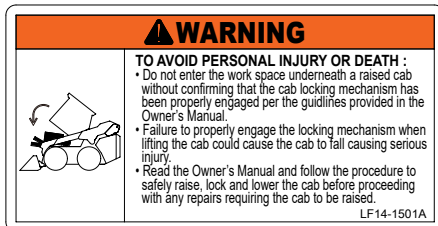

(4) Part number: LF14-1500A

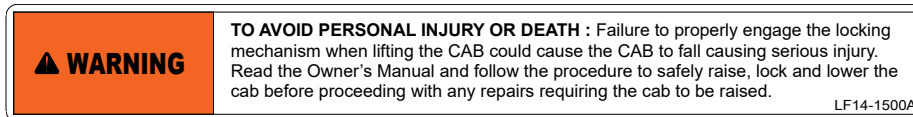

(3) Part number: LF14-1502A

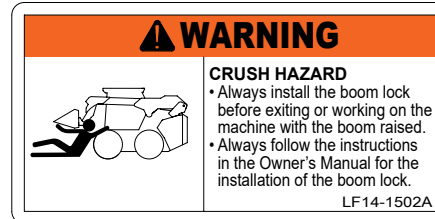

(5) Part number: LF18-0017



(6) Part number: LF18-0011

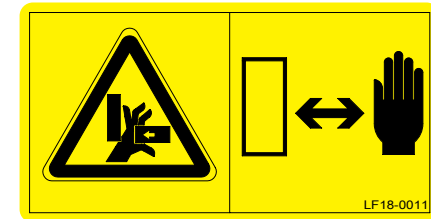

(7) Part number: LF18-0023

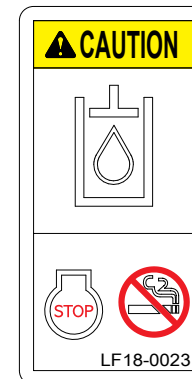

1



(8) Part number: LF14-1501A

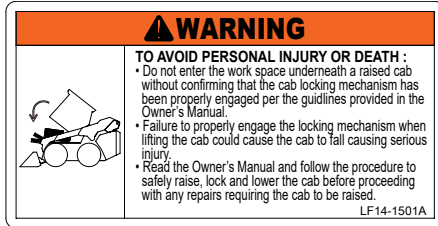

(10) Part number: LF18-0044

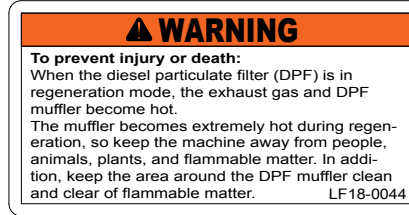

(12) Part number: LF18-0016

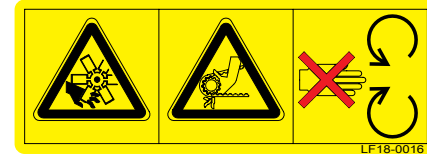

(9) Part number: LF18-0049

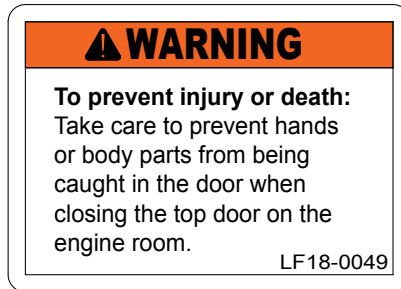

(11) Part number: LF18-0015



(13) Part number: LF18-0069

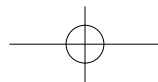
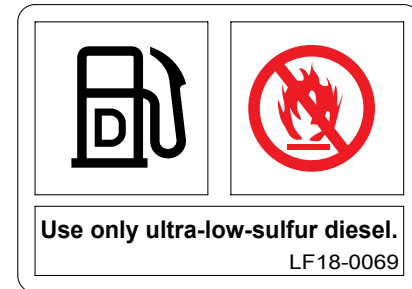



(14) Part number: LF18-0051

⚠ WARNING	
<p>Battery explosions may be caused by cigarettes, flames, or sparks. Always protect your eyes and face from the battery. Do not charge or use booster cables or adjust the connection ports without proper guidelines and training.</p> <p>Tighten the vent cap firmly and keep it in a horizontal position. Poisonous substances can cause severe burns. Battery electrolyte contains sulfuric acid. Do not allow it to come into contact with skin, eyes, or clothes. In the event of an accident, wash it off immediately with clean water and consult a physician. Keep out of reach of children.</p>	
LF18-0051	

(15) Part number: LF18-0024

LF18-0024	

(17) Part number: LF18-0071

⚠ WARNING	⚠ WARNING
<p>The operation of this equipment may produce flames which can cause a fire around dry matter. A flame removal device is needed. The operator must comply with all relevant legislation and fire prevention requirements.</p>	<p>To prevent injury:</p> <ul style="list-style-type: none"> • Make sure to read and understand the owner's manual before operating the machine. • Familiarize yourself with all controls. • Check to make sure that the surrounding area is clear of people before operating the machine. • Keep all safety devices in place. • Do not allow people to ride on implements or on the outside of the vehicle. • Before leaving the machine, lower all implements to the ground, turn off the engine, and remove the key. <p style="text-align: right;">LF18-0071</p>

1

(16) Part number: LF14-1498A

⚠ DANGER	
TO AVOID SERIOUS INJURY OR DEATH :	
<ul style="list-style-type: none"> • To prevent injury, never leave the operator's station with the boom or the attachment raised in the air. Before exiting the machine, the boom should be lowered resting securely on the stops or lower limits. • In the event of power loss or in an emergency with no hydraulic functions, remain seated and be sure the area underneath the boom and/or attachment is clear. Press the emergency auxiliary release button to lower the boom and/or attachment safely. 	
LF14-1498	

(18) Part number: LF14-0908

LF14-0908



(19) Part number: LF18-0033

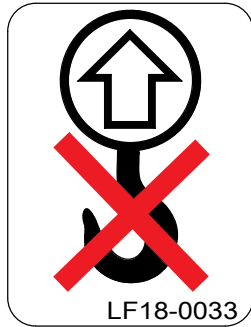

(21) Part number: LF14-1505A

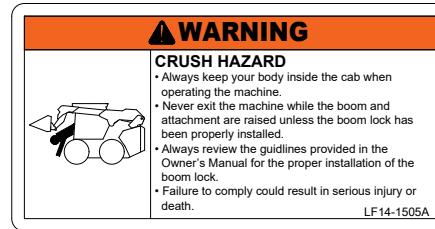

(23) Part number: LF14-1504A

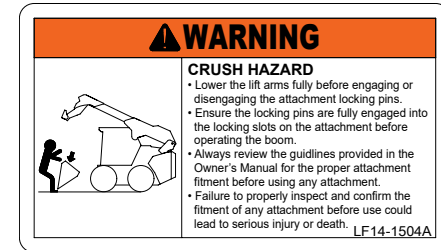

(22) Part number: LF18-0028



(20) Part number: LF18-0029

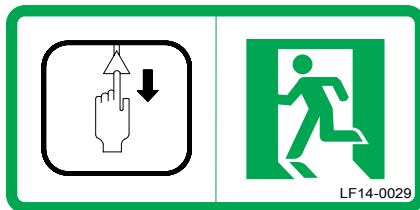

(24) Part number: LF18-0054

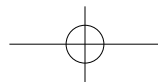
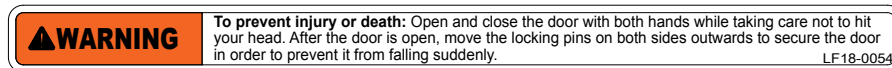



(25) Part number: LF14-0984

⚠ WARNING

TO AVOID PERSONAL INJURY :
When opening and closing the door,
be careful not to hit the window with
your head or other parts of your body.
LF14-0984

(26) Part number: LF14-1331

⚠ WARNING

When tilting the cabin, make
sure to proceed with the engine
turned off.
LF14-1331

CAUTIONS FOR DECAL MAINTENANCE

Safety decals are attached to the machine for safe operation. Make sure to follow the instruction on the decals as well as the following instruction:

⚠ CAUTION

- **Keep the decals clean and intact. If any decal is dirty, wash it with soap and water and dry with a soft cloth.**
- **Never use a solvent, such as thinner or acetone, since it can ruin the decals.**
- **Do not spray high-pressure water directly onto the decal. The decal may fall off the machine.**

⊕ IMPORTANT

- **If a decal is damaged or lost, contact your local dealer immediately to install a new decal.**
- **Make sure to attach the decal to the correct position cleanly without bubbles after cleaning its mounting surface.**
- **If a decal is attached to a component to be replaced, replace the decal as well.**

1

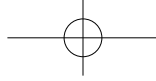

MEMO





BEFORE OPERATION

VEHICLE IDENTIFICATION NUMBER	2-2
PRODUCTION SERIAL NUMBER	2-2
ENGINE SERIAL NUMBER	2-2
ESSENTIAL REPLACEMENT PARTS	2-3
OILS AND FLUIDS	2-3
BELTS AND RUBBER PARTS	2-3
FILTERS	2-4
OTHER COMPONENTS	2-4

2

2



VEHICLE IDENTIFICATION NUMBER PRODUCTION SERIAL NUMBER ENGINE SERIAL NUMBER



(1) Production serial number

The production serial number is the number by which to identify a product, which is attached on the front of the machine.



(1) Engine serial number

The engine serial number is engraved on the cylinder block behind the gear case.

When in need of parts, be prepared to give your dealer both the machine and engine serial numbers.

Fill in the following fields so that the production and engine serial numbers can be provided immediately when service is needed:

• Machine serial number

• Engine serial number

• Date of Purchase

(To be filled in by purchaser)

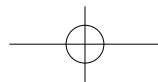



ESSENTIAL REPLACEMENT PARTS OILS AND FLUIDS



Various oils and fluids are used in this machine for operation, lubrication, cooling, and anti-corrosion of various parts.

If oil or fluid is insufficient, contaminated or degraded, it can cause poor performance, incorrect operation, and seized parts of the machine, leading to malfunction.

Regularly add or change the fluid specified on the right to keep the machine in good condition.

No.	Part name	Spec.	Capacity [us gal (ℓ)]
1	Engine oil (including the filter)	Spec: API CJ-4 grade or higher Viscosity (SAE): SAE 15W40	2.4 (9)
2	Hydraulic oil	ISO VG 46	10.0 (38)
3	Chain box (each on the left and right)	SAE 10W-30 or equivalent	3.4 (13)
4	Grease	SAE multi purpose type grease	As needed
5	Anti-freezer	Fresh clean water with ethylene glycol (50:50)	2.75 (10.4)

BELTS AND RUBBER PARTS

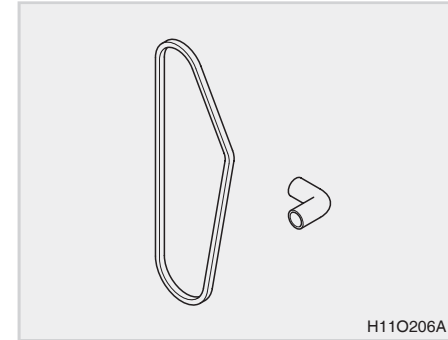

2

Belts, hoses and boots, which are made of rubber, get weakened and cracked as they age. If these parts are kept used in this state, they can be broken off, leading to a serious problem in the machine. Therefore, regularly check or replace those items to prevent the failure.

No.	Part No.	Part name	Qty
1	EH52-0001A	Fan belt	1

FILTERS

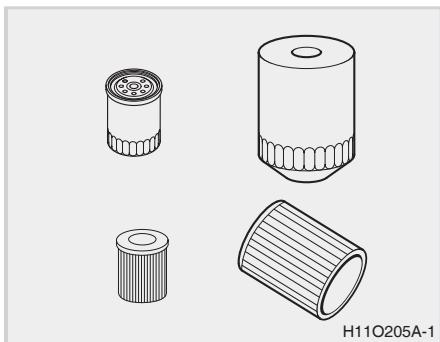

Filters for the engine, transmission, air cleaner, and A/C are consumables that purify oil and air. Make sure to replace these items when changing oil.

No.	Part No.	Part name	Qty
1	LF13-0697A	Hydraulic filter element - HST	1
2	LF13-0698A	Hydraulic filter element - Return	1
3	LF11-0097A	Intake air filter	1
4	EH35-0011A	Fuel filter	1
5	E6201-32443	Oil filter	1
6	T4710-11081	Element	1

OTHER COMPONENTS

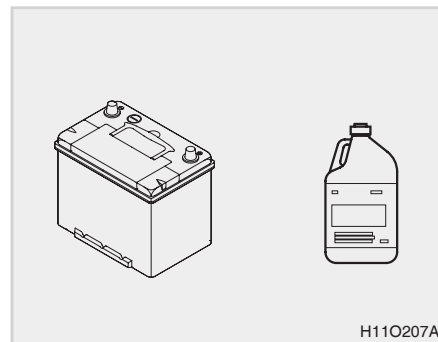

The battery condition is very important for engine starting performance, especially in winter. Therefore, make sure to check its condition daily to prevent its discharge. Also, check its service life and electrolyte condition regularly. There is a battery cutoff switch in the rear of the machine to help prevent discharge as well.

No.	Part No.	Part name	Qty
1	TG15-0150B	Battery (110AH)	1



SPECIFICATIONS

SPECIFICATIONS **3-2**

EXTERNAL DIMENSIONS 3-2

GENERAL SPECIFICATIONS 3-3

OPTION LIST AND FEATURES 3-5

3

3

SPECIFICATIONS

EXTERNAL DIMENSIONS

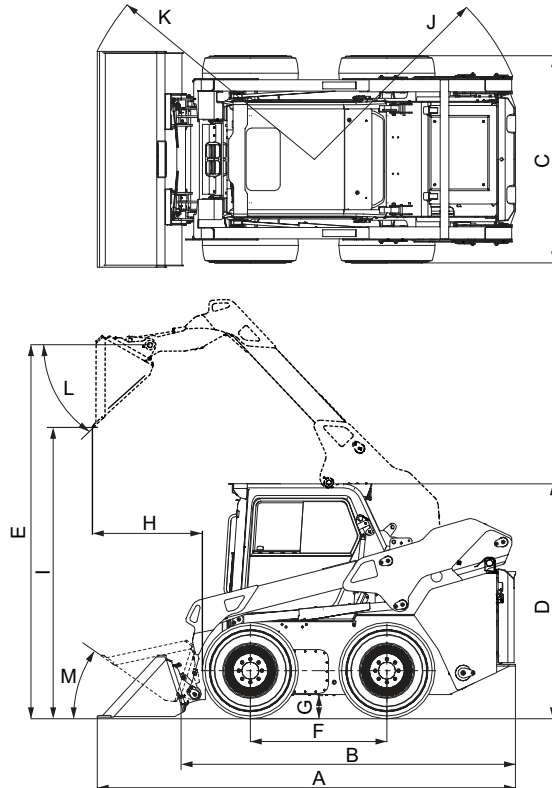

LF10301D

Item		SL750	Remarks
1. Overall length (A)	in.(mm)	114.7 (3,675)	※ Including the bucket
2. Overall length (B)	in.(mm)	116.5 (2,960)	※ Excluding the bucket
3. Overall width (C)	in.(mm)	71.7 (1,820)	※ Excluding the bucket
4. Overall height (D)	in.(mm)	85.1 (2,161)	※ To top of the cab
5. Max. height to hinge pin(E)	in.(mm)	126.6 (3,215)	
6. Wheel base (F)	in.(mm)	47.2 (1,200)	
7. Ground clearance (G)	in.(mm)	7.7 (195)	
8. Reach at Max Height (H)	in.(mm)	37.4 (949)	
9. Dumping height (I)	in.(mm)	97.4 (2,473)	
10. Turning radius (J)	in.(mm)	70.4 (1,788)	※ Rear
11. Turning radius (K)	in.(mm)	85.0 (2,158)	※ Front of bucket
12. Dumping angle (L)	°	42	
13. Rollback angle (M)	°	29	※ Carry position

※ Note: These dimensions are based on the exterior dimensions of SL750 (PL/PLQF/LQ/LQF).
 Dimesions are based on machine equipped with a 74" bucket.



GENERAL SPECIFICATIONS

Item			Model				
			SL750U-PL	SL750U-PLQF	SL750U-LQ	SL750U-LQF	
Engine	Model		KIOTI 4HTI4				
	Rated power (Gross)		HP(kW)		73.6 (54.9)		
	Rated RPM		rpm		2,400		
	No. of cylinders				4 cylinders		
	Displacement		cc (cu in.)		2,435 (148)		
Capacity	Fuel tank		us gal (ℓ)		26.4 (100)		
	Engine oil (including the filter)		us gal (ℓ)		2.4 (9)		
	Coolant		us gal (ℓ)		2.75 (10.4)		
	Hydraulic tank		us gal (ℓ)		10.0 (38)		
	Chain box (LH/RH)		us gal (ℓ)		3.4 (13)		
Hydraulic	Standard flow	Loader pressure	psi (bar)		3,335 (230)		
		Loader flow	gpm (lpm)		21.9 (82.9)		
	High flow (Optional)	Loader pressure	psi (bar)	-	2,176(150)	-	2,176(150)
		Loader flow	gpm (lpm)	-	34.0(128.8)	-	34.0(128.8)
		Hydraulic output	HP (kW)	-	42.3(31.5)	-	42.3(31.5)

Item			Model			
			SL750U-PL	SL750U-PLQF	SL750U-LQ	SL750U-LQF
Driving	Speed - Low range	mph (kph)	7.15 (11.5)			
	Speed - High range	mph (kph)	12.05 (19.4)			
	Tires		12-16.5-12PR			
Operation	Operating weight (with operator)	lb (kg)	8,362 (3,793)	8,514(3,862)	8,633(3,916)	8,735(3,962)
	Rated operation capacity	lb (kg)	2,689 (1,220)			
	Tipping load	lb (kg)	5,380 (2,440)			
	Breakout Force, Tilt (Bucket)	lb (kg)	5,512 (2,500)			
	Breakout Force, Lift	lb (kg)	5,016 (2,275)			
	Lift Arm Type		Vertical			
	Controls		ISO Pilot Joystick Controls			
Cabin	ROPS		O(Authentication completed)			
	FOPS		O(Authentication completed)			

※ Note: The specifications are subject to change without notice.



OPTION LIST AND FEATURES

ITEM	Model			
	SL750U-PL	SL750U-PLQF	SL750U-LQ	SL750U-LQF
2 speed	Std	Std	Std	Std
High Flow hydraulics	-	Std	-	Std
Bucket Self-leveling	Std (Up only)	Std (Up only)	Std (Up only)	Std (Up only)
AUX hydraulic	Std	Std	Std	Std
Power quick attach (Hyd.)	-	Std	Std	Std
Ride Control (Shock Absorb)	-	Std	Std	Std
Air condition / Heater	-	-	Std	Std
Suspension seat	Std	Std	Std	Std
Seat Belt (2 inch)	Std	Std	Std	Std
Seat Belt (3 inch)	Opt	Opt	Opt	Opt
Hyd. Oil (VG46)	Std	Std	Std	Std
Hyd. Oil (VG32) for Cold Area	Opt	Opt	Opt	Opt
Remote Control - ISO	Std	Std	Std	Std
Bucket - 74" (0.44m ²)	Opt	Opt	Opt	Opt
Bucket - 78" (0.56m ²)	Opt	Opt	Opt	Opt

※ Notes: Some option kits are not available at the time of printing. The specifications are subject to change without notice. Some option kits are installed as a standard in a certain country.



ITEM	Model			
	SL750U-PL	SL750U-PLQF	SL750U-LQ	SL750U-LQF
CAB	-	-	Std	Std
Canopy	Std	Std	-	-
Beacon light	Opt	Opt	Opt	Opt
Side Mirror	Std	Std	Std	Std
Turn light	Opt	Opt	Opt	Opt
Reflector	Std	Std	Std	Std
License plate light	Opt	Opt	Opt	Opt
Back Buzzer	Std	Std	Std	Std
Stop light	Std	Std	Std	Std
Extinguishers-Small (0.7kg)	Std	Std	Std	Std
Radio / Blue tooth / USB	-	-	Opt	Opt
Tool box	Std	Std	Std	Std
Work light - Front (LED - 2EA)	Std	Std	Std	Std
Work light - Rear (LED - 2EA)	Std	Std	Std	Std
Escort lamp	Std	Std	Std	Std

※ Notes: Some option kits are not available at the time of printing. The specifications are subject to change without notice. Some option kits are installed as a standard in a certain country.



ITEM	Model			
	SL750U-PL	SL750U-PLQF	SL750U-LQ	SL750U-LQF
Rear View Camera	Std	Std	Std	Std
Luxen (PC) Glass	-	-	Opt	Opt
Solid Tire, 8.25-15	Opt	Opt	Opt	Opt

※ Notes: Some option kits are not available at the time of printing. The specifications are subject to change without notice. Some option kits are installed as a standard in a certain country.

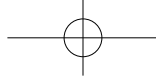

MEMO

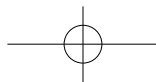



FUNCTION DESCRIPTION AND OPERATING TIPS

EXTERIOR VIEW	4-3	CONTROLS	4-18
SWITCHES.....	4-5	RIGHT JOYSTICK CONTROL LEVER (LIFT ARM & BUCKET).....	4-19
MOUNTING LOCATION	4-5	LEFT JOYSTICK CONTROL LEVER (DRIV- ING).....	4-20
KEY SWITCH.....	4-7	HOW TO OPERATE EXTERNAL HYDRAU- LIC PRESSURE	4-23
ENGINE ACCELERATION DIAL	4-8	HOW TO OPERATE THE HIGH FLOW FUNC- TION	4-24
HYDRAULIC UNLOCK SAFETY SWITCH... 4-8		14-PIN AUXILIARY POWER OUTLET.....	4-24
PARKING SWITCH	4-9	HOW TO OPERATE THE AUXILIARY POWER..	4-25
WORK LIGHTS SWITCH.....	4-9	THROTTLE PEDAL.....	4-26
TURN SIGNAL LAMP SWITCH.....	4-10	INSTRUMENT PANEL	4-26
SELF-LEVELING SWITCH (IF INSTALLED).. 4-11		INSTRUMENT PANEL FEATURES	4-26
WIPER/WASHER SWITCH (CABIN MOD- EL ONLY).....	4-11	TACHOMETER/HOUR METER.....	4-28
HAZARD WARNING FLASHER SWITCH.. 4-12		HYDRAULIC OIL TEMPERATURE GAUGE..	4-28
AUX (AUXILIARY HYDRAULICS) PORT SWITCH SWITCH.....	4-12	FUEL GAUGE	4-28
HIGH FLOW SWITCH.....	4-13	ENGINE COOLANT TEMPERATURE GAUGE	4-29
HYDRAULIC LOCK SWITCH	4-14	MENU SWITCH	4-30
HYDRAULIC QUICK ATTACH SYSTEM (IF INSTALLED).....	4-14	LEFT/RIGHT MENU SWITCH/CAMERA SWITCH.....	4-30
DPF REGENERATION SWITCH.....	4-15	ENTER SWITCH	4-30
BEACON LAMP SWITCH (OPTIONAL)	4-16		
A/C SWITCH (CABIN MODEL ONLY).....	4-17		
INTERIOR LAMP SWITCH.....	4-17		

4



FUNCTION DESCRIPTION AND OPERATING TIPS

ESC / BUZZER OFF BUTTON	4-31	ANTENNA	4-54
HAZARD FLASHER	4-31	INTERIOR LAMP	4-54
ENGINE OIL PRESSURE WARNING LAMP ..	4-31	ACCESSORIES	4-54
ENGINE PRE-HEATING INDICATOR	4-32	POWER SOCKET & USB SOCKET	4-54
CHECK ENGINE WARNING LAMP	4-32	RADIO & USB PLAYER (CABIN MODEL ONLY - OPTIONAL)	4-55
DPF REGENERATION WARNING LAMP ..	4-33	HEATER AND A/C (CABIN MODEL ONLY) ..	4-56
DPF REGENERATION PROCESS INDICATOR	4-33	ADJUSTING THE SEAT	4-60
WATER-IN-FUEL WARNING LAMP	4-33	MCU (MACHINE CONTROL UNIT)	4-62
PARKING BRAKE LAMP	4-34	EMERGENCY EXIT	4-62
SAFETY COVER WARNING LAMP	4-34	MANUAL QUICK ATTACH SYSTEM	4-63
SAFETY BAR WARNING LAMP	4-35	REMOVING THE BUCKET (MANUAL TYPE) ..	4-63
BATTERY CHARGE WARNING LAMP	4-35	INSTALLING AND REMOVING THE BUCKET (HYDRAULIC QUICK ATTACH SYSTEM)....	4-64
REAR-VIEW CAMERA	4-36	BOOM LOCK	4-64
MAIN AND SUB-MENU	4-37	RELEASING THE LIFT ARM	4-66
MACHINE DIAGNOSIS	4-48	RAISING THE CANOPY AND CABIN	4-67
CABIN & CANOPY	4-51	LOWERING THE CANOPY AND THE CABIN ..	4-68
INTERIOR DEVICES (CABIN MODEL ONLY) ..	4-51	TIRES	4-69
EXTERIOR DEVICES	4-51	TIRE INFLATION PRESSURE	4-70
DOOR (CABIN MODEL ONLY)	4-52	WHEEL TORQUE	4-70
DOOR STOPPER (CABIN MODEL ONLY) ..	4-52		
WORK LAMP	4-52		
WIPER (CABIN MODEL ONLY)	4-53		



EXTERIOR VIEW

CABIN



4

- (1) Tilt cylinder
- (2) Bucket
- (3) Tire
- (4) ROPS cabin

- (5) Lift arm
- (6) Lift cylinder
- (7) Rear tailgate
- (8) Front and Rear work lights

- (9) Antenna
- (10) Beacon lamp
- (11) Turn signal lamp
- (12) Boom lock

- (13) Auxiliary coupler block
- (14) Side mirror
- (15) Rear Work Lights

LF10401D



CANOPY



- (1) Tilt cylinder
- (2) Bucket
- (3) Tire
- (4) ROPS cabin

- (5) Lift arm
- (6) Lift cylinder
- (7) Rear tailgate
- (8) Front and Rear work lights

- (9) Antenna
- (10) Beacon lamp
- (11) Turn signal lamp
- (12) Boom lock

- (13) Auxiliary coupler block
- (14) Side mirror
- (15) Rear Work Lights

LF104P4B

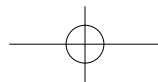



SWITCHES MOUNTING LOCATION



- (1) Engine acceleration dial
- (2) Right joystick control lever (Lift arm & bucket)
- (3) Seat bar
- (4) Relay box
- (5) Instrument panel
- (6) Key switch
- (7) Power outlet
- (8) Stereo
- (9) Operator's seat
- (10) Left joystick control lever (driving)
- (11) HVAC controller
- (12) Right control panel
- (13) Left control panel

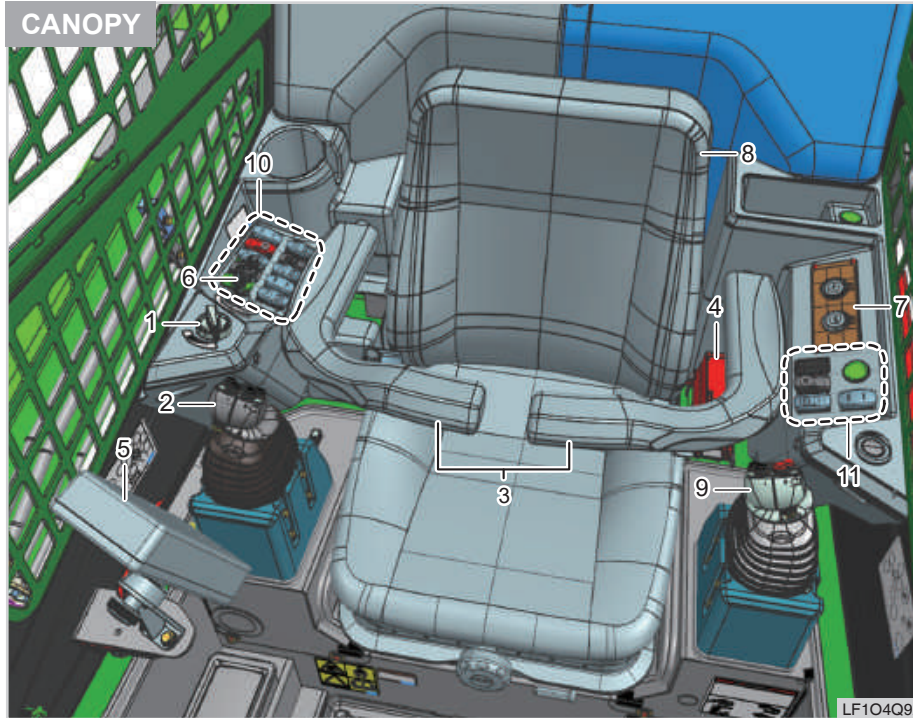

- (1) Engine acceleration dial
- (2) Right joystick control (lift arm & bucket)
- (3) Seat bar
- (4) Relay box (Cabin)
- (5) Instrument panel
- (6) Key switch
- (7) Power outlet
- (8) Operator's seat
- (9) Left joystick control (driving)
- (10) Right control panel
- (11) Left control panel



KEY SWITCH

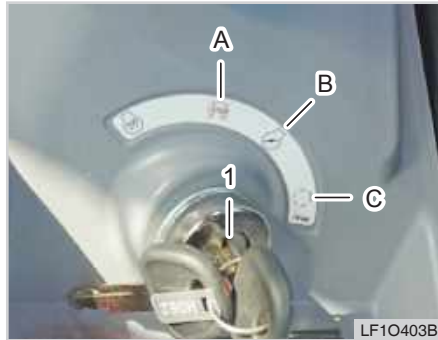

(1) Key switch

(A) OFF

(B) ON

(C) START

- **OFF (A)**

The position "A" indicates the "OFF" position. This allows for inserting or removing the ignition key, and while the engine is running, turn the key to "OFF" position to turn off the engine.

- **ON (B)**

The position "B" indicates the "ON" position. It turns on the whole system of the machine.

- **START (C)**

The "C" position is the ignition location, which is used to turn on the engine. Remove your hand as soon as the engine starts.



CAUTION

- **Stop the engine immediately if the oil pressure warning lamp does not go off after the engine is started. The engine may be severely damaged.**
- **If the battery charge warning lamp does not go off after the engine is started, check the electrical systems, such as the alternator, for damage. Continuing to use the engine under this condition can discharge the battery or damage other electrical devices.**



NOTE

- This machine is equipped with the restart prevention system so that even if the key is on the START position, while the engine is running, it won't restart the engine.



ENGINE ACCELERATION DIAL

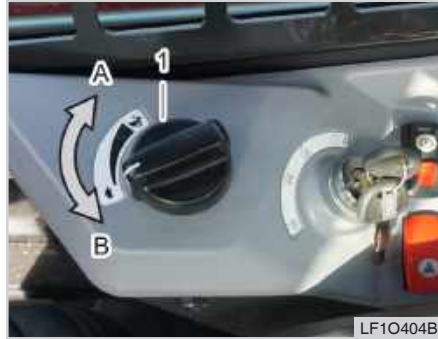

(1) Engine acceleration dial
(A) Acceleration (B) Deceleration

This dial controls the RPM of the engine. Turn the dial to the right to increase the RPM, and turn it to the left to decrease the RPM.

To stop the engine, turn the dial to the left to reduce the RPM to its minimum, and turn the ignition key to "OFF".

HYDRAULIC UNLOCK SAFETY SWITCH



(1) Hydraulic unlock safety switch

Use this switch to unlock (reset) the operation system which is locked for safety.

When you pull up the seat bar while the engine is running or turn off the engine, the machine automatically is set to the parking state. After lowering the seat bar, press the switch to release the lock and work is possible.



PARKING SWITCH



(1) Parking switch

When parking, press the switch. When the switch is pressed, the parking and driving devices are locked and the parking lamp ((P)) is turned on.

NOTE

- If you lift the seat bar or turn off the engine while starting, it automatically enters a parked state.

WORK LIGHTS SWITCH



(1) Main light switch
(A) OFF (B) Step 1 (C) Step 2

This switch is in two steps to turn on the front and rear work lamps in sequence.

Switch	Functions
OFF	OFF position
Step 1	The front work lamp (head-lamp) comes on.
Step 2	The front/rear work lamps come on.

TURN SIGNAL LAMP SWITCH



(1) Turn signal lamp switch
 (A) Right turn (B) Left turn

The turn signal lamp switch is used when you want to change the turning direction of the machine or to warn other vehicles or machines. Press the lower part to have the left turn signal lamp blink, and press the upper part to have the right turn signal lamp blink.



NOTE

- The turn signal lamp switch is not a self-return type. Therefore, make sure to return the switch manually after turning the machine.
- The turn signal lights can be operated without the key inserted.

SELF-LEVELING SWITCH (IF INSTALLED)



LF1O4D1A



LF1O4P9A

(1) Self-levelling switch

This switch is used for the self-leveling operation. When in operation, the self-levelling lamp (🔦) activates on the instrument panel.

The self-levelling function maintains roughly a parallel position between the attachment and the ground automatically according to the elevation angle of the lift arm.

WIPER/WASHER SWITCH (CABIN MODEL ONLY)



LF1O410C

4

(1) Wiper / washer switch
(A) OFF (B) Step 1 (C) Step 2

This switch is in two steps to run the wiper and the washer in sequence.

Switch	Functions
OFF	OFF position
Step 1	The wipers are on.
Step 2	The washer fluid is sprayed and the wipers are on. The washer function is activated only when the switch is pressed. When the switch is not pressed, the wipers return to their original location.

HAZARD WARNING FLASHER SWITCH



LF1O4D2A



LF1O4Q1A

(1) Hazard warning flasher switch

This switch can be used to warn other vehicles when malfunction occurs in the vehicle while driving on a public road. The turn signal lights cannot be operated while the hazard warning flasher is in operation.

AUX (AUXILIARY HYDRAULICS) PORT SWITCH SWITCH



LF1O405A



LF1O4Q2A

(1) AUX switch





HIGH FLOW SWITCH

This switch controls the external hydraulic pressure and power function and can be used after the attachment is installed. When you press the button, the AUX lamp () on the instrument panel comes on. When using the external hydraulic pressure, press the switch (ON) and control the pressure by the joystick switch and dial on the right. (refer to page 4-17.)



- (1) High flow switch
- (2) AUX switch

This switch is used for work that requires additional flow due to the addition of attachments, and the system operates by running the AUX pump (high flow pump).

It can be used by pressing the AUX button, which turns on the AUX lamp (), AUX hydraulic lamp () and high flow lamp (). (refer to page 4-18).

HYDRAULIC LOCK SWITCH



LF1O405A



LF1O4Q3A

(1) Hydraulic lock switch

When this switch is pressed, the hydraulic line for operating the implements (lift arm, AUX) is blocked and the instrument panel hydraulic lock indicator (🔒) is turned on.

HYDRAULIC QUICK ATTACH SYSTEM (IF INSTALLED)



LF1O4D7A

(1) Quick attachment switch

It is used to attach or detach attachments.

⚠ WARNING

- ***If the lock is released while driving, the attachment may fall onto the cabin. Therefore, never use the unlock function while driving.***



DPF REGENERATION SWITCH



(1) DPF regeneration switch

(A) Activation

(B) Deactivation

DPF is a device that reduces soot (a kind of carbon-containing soot or soot) among exhaust gas components emitted from diesel engines. The function automatically operates while driving, but if the DPF does not operate normally, accumulated harmful substances may block the filter, which may lead to poor performance of the vehicle without proper exhaust.

If carbon is accumulated in the exhaust DPF, this warning lamp comes on or

blinks. If this warning lamp comes on, press the "regeneration" button.

ACTIVATION (UPPER PORTION OF SWITCH)

Perform the following instructions when the regeneration warning lamp comes on:

1. Park the machine on a flat surface.
2. Idle the engine.
3. Press the parking switch. (Please make sure that the P lamp comes on)
4. Run the engine for 3 to 4 minutes. Then, press the activation portion of the regeneration switch for approx. 2 seconds.
5. The regeneration warning lamp goes off and the regeneration process lamp blinks.

Before resuming your work, wait for approx. 30 to 40 minutes until the regeneration process is completed.

NOTE

- The illumination timing of the regeneration process lamp may differ depending on the DPF temperature.

DEACTIVATION (LOWER PORTION OF SWITCH)

Do not press the deactivation button while the regeneration process is activated.

However, the switch can be set to the deactivation position to stop the regeneration process in emergency. (For example, when excessive white smoke occurs.)

CAUTION

To protect the catalyst filter, keep the followings:

- **Make sure to use only genuine fuel.**
- **Change and replace the oil and filters per the recommended schedule.**
- **Check the engine oil level frequently to keep it to the specified level.**
- **Avoid any unnecessary engine idling.**
- **Never stop the engine while driving.**
- **Do not use any engine oil additive or fuel additive.**
- **In order to prevent damage to the catalytic filter, avoid prolonged driving with any warning lamp illuminated.**
- **Do not allow any flammable materials, such as dry grass and paper, to come near the catalyst filter while parked.**

BEACON LAMP SWITCH (OPTIONAL)



(1) Beacon lamp switch

To increase the visibility of your equipment, press the beacon lamp switch to activate the light on top of the cabin.

CAUTION

- **If the beacon lamp is turned on for an extended period of time while the engine is stopped, the battery can be discharged.**



A/C SWITCH (CABIN MODEL ONLY)



(1) A/C switch

This switch is used to control the heater. It is only applied to the vehicle equipped with an A/C. (For details, refer to the page 4-51.)

INTERIOR LAMP SWITCH



(1) Interior lamp ON/OFF switch

Press the button to turn the Interior lamp on or off.

CONTROLS



- (1) Right control lever (lift arm & bucket)
- (2) Left control lever (driving)
- (3) Throttle pedal



RIGHT JOYSTICK CONTROL LEVER (LIFT ARM & BUCKET)



LF1O4E1A

- (1) Right joystick control lever
(2) AUX electric mode activation button

The right control lever is used to control the lift arm and the bucket. Also, with the AUX button on the joystick pressed, the joystick can be used for powered attachment use. (However, any electric work can be performed only after pressing the AUX electric mode activation button.)

JOYSTICK CONTROL LEVER OPERATION

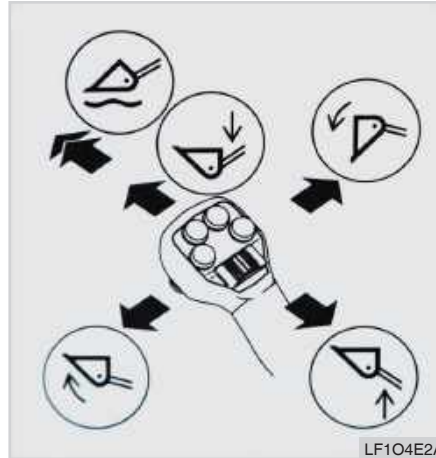

LF1O4E2A

Direction	Function
	Float
	Bucket curl
	Bucket dump
	Lift arm up
	Lift arm down

JOYSTICK CONTROL LEVER BUTTON OPERATION

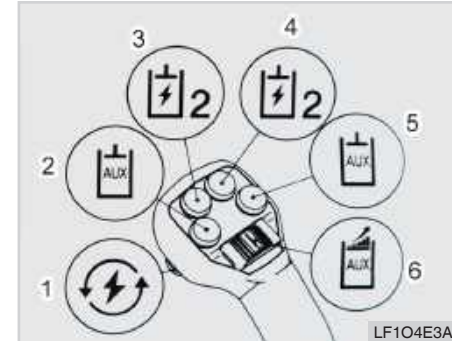

LF1O4E3A

4

No.	Button	Function
1		AUX electric mode activation button
2		AUX port: Male coupler port (refer to page 4-18)
3		14-pin power supply-E
4		14-pin power supply-F
5		AUX port: Female coupler port (refer to page 4-18)
6		AUX jog dial (M ← → F)

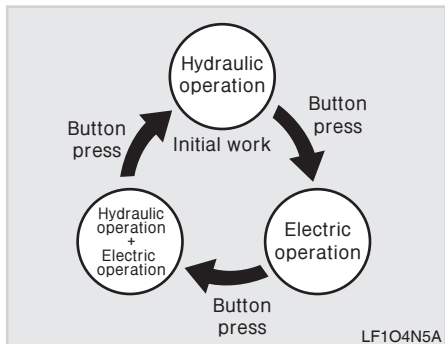

AUX ELECTRIC MODE ACTIVATION BUTTON



draulic operation mode. The lamp on the instrument cluster also indicates the current operating state.

- With AUX switch OFF:
No auxiliary operation mode can be activated.

- With AUX switch ON:

Initially, the auxiliary hydraulic operation mode () is activated. Pressing the AUX electric mode activation button activates the auxiliary electric operation mode (). Pressing the button again enables simultaneous auxiliary hydraulic operation and auxiliary electric operation mode (). When pressing the button again, the activation cycle is reset, starting from the initial auxiliary hy-

LEFT JOYSTICK CONTROL LEVER (DRIVING)

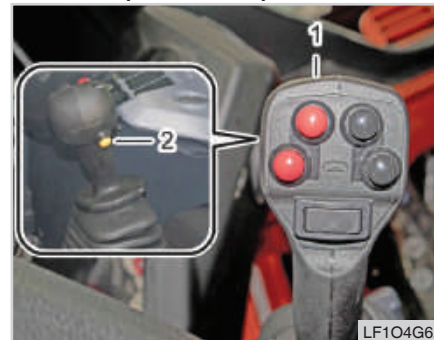

(1) Left control lever (2) 2-speed button

With the left control lever, you can move the vehicle forward or backward, and turn it to the left and right. In addition, the AUX power operation, ride control, 2-speed and horn functions can be used by pressing the buttons on the joystick control.

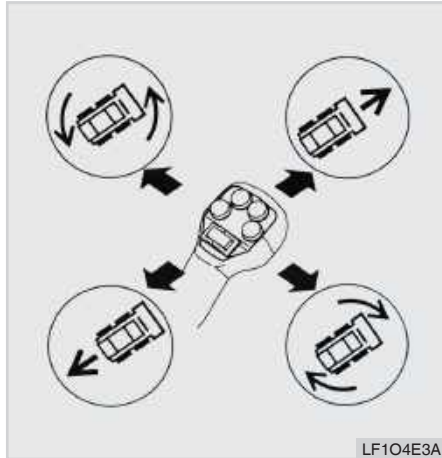
**JOYSTICK CONTROL LEVER OPERATION**

Direction	Function
	Forward
	Reverse
	Left turn
	Right turn

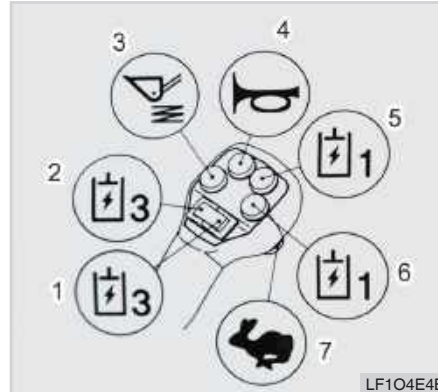
JOYSTICK CONTROL LEVER BUTTON OPERATION

No.	Button	Function
1		14-pin power supply-G
2		14-pin power supply-H
3		Ride control (Cabin model only)
4		Horn button
5		14-pin power supply-C
6		14-pin power supply-D
7		2-speed button

RIDE CONTROL (CABIN MODEL ONLY)

(1) Ride control button

When operating with a load on uneven terrain, material in the bucket or attachment can spill as one operates. The shock from driving over rough ground can be transferred from the ground into the loader arms and eventually all the way out to the attachment, causing unwanted material spillage. If equipped, the ride control feature on your compact loader can dampen the effects via an accumulator reducing the chance of material spillage and/or

the need for site clean up.

When in operation, the ride control lamp (🚧) on the instrument panel comes on.

HORN BUTTON



(1) Horn button

The horn button can be operated without the key inserted. Pressing this button sounds the horn.

2-SPEED BUTTON

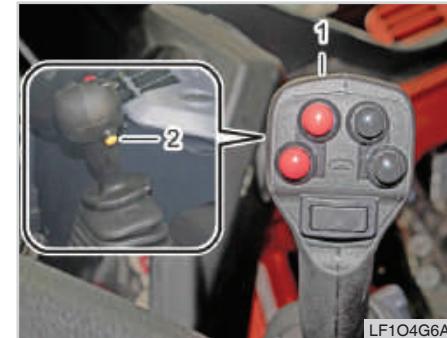

(1) Left control lever (2) 2-speed button

The vehicle speed can be controlled in two steps by the driving motor. Pressing the button while driving allows for the second (high-speed) driving mode. When in operation, the 2-speed lamp (🚧) on the instrument panel comes on.



HOW TO OPERATE EXTERNAL HYDRAULIC PRESSURE



(1) AUX switch

1. Turn the AUX switch ON.

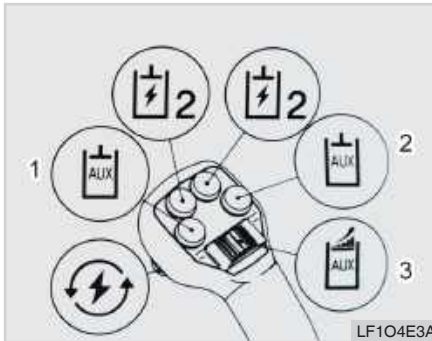

- (1) Male coupler operation button
 (2) Female coupler operation button
 (3) Jog dial

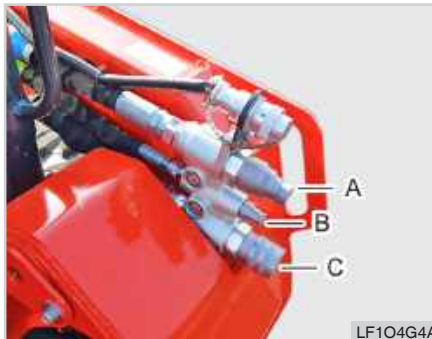

- (A) Male coupler port
 (B) Return port
 (C) Female coupler port

2. Press the right control lever button 1 to continue supplying hydraulic pressure to the male coupler.
3. Press the right control lever button 2 to continue supplying hydraulic pressure to the female coupler.
4. The flow level can be controlled by the jog dial, and more flow will be introduced by pushing it from the center to the edge. Push the jog dial to the left to supply the hydraulic pressure to the male coupler and to the right to supply it to the female coupler.
5. It is possible to set the flow level of each button (1, 2). Please refer to the setting function on the instrument panel. (Page 4-38, 'Hydraulic pressure control'.)

HOW TO OPERATE THE HIGH FLOW FUNCTION



LF1O4D5C

- (1) AUX switch
(2) High flow switch

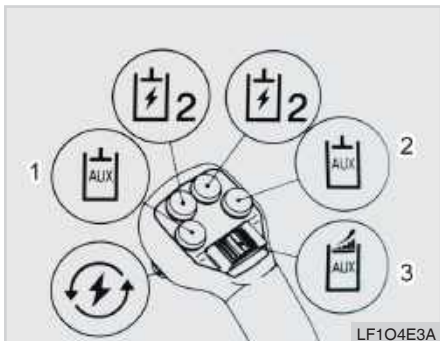

LF1O4E3A

- (1) Male coupler operation button
(2) Female coupler operation button
(3) Jog dial

1. Turn on the AUX switch and high flow switch.
2. Turn the right joystick control button 1 or jog dial to the left to operate the high flow function to the male coupler, which allows for more flow supply.



CAUTION

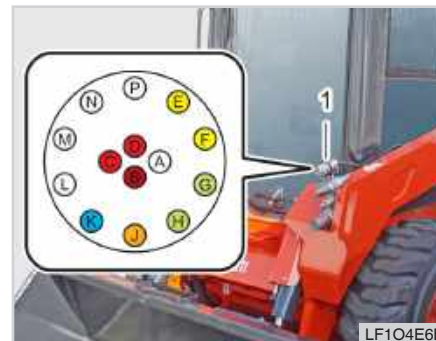

- The high flow function can be activated by operating the right joystick control button 1 or turning the jog dial to the left and is only applied to the male coupler.

14-PIN AUXILIARY POWER OUTLET



LF1O4E6B

- (1) 14-pin auxiliary power outlet

To utilize an attachment with electrical functions, Fully connect the attachment. Turn on the AUX switch and press the AUX electric mode activation button on the right control lever to activate the aux. power outlet, at which the AUX lamp () and AUX power indicator () on the instrument panel come on. When pressing the left or right control lever button to output the power, the port lamp to which the power is applied () comes on in the instrument panel.



HOW TO OPERATE THE AUXILIARY POWER



- (1) Right control lever
(2) AUX electric mode activation button

1. Turn on the AUX switch.
2. Press the AUX electric mode activation button (2) on the right control lever to use the auxiliary external power.

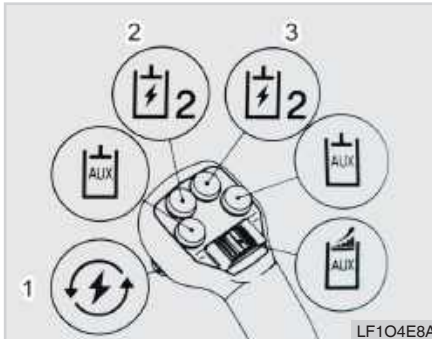

- (1) AUX electric mode activation button
(2) 14-pin power supply-E
(3) 14-pin power supply-F

3. Press the right control lever button 2 to supply power to the aux. power outlet - E pin.
4. Press the right control lever button 3 to supply power to the auxiliary power outlet - F pin.

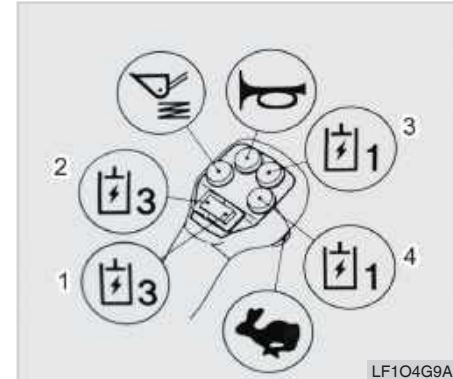

- (1) 14-pin power supply-G
(2) 14-pin power supply-H
(3) 14-pin power supply-C
(4) 14-pin power supply-D

5. Press the left control lever button 1 to supply power to the auxiliary power outlet - G pin.
6. Press the left control lever button 2 to supply power to the auxiliary power outlet - H pin.
7. Press the left control lever button 3 to supply power to the auxiliary power outlet - C pin.

8. Press the left control lever button 4 to supply power to the auxiliary power outlet - D pin.

THROTTLE PEDAL



(1) Throttle pedal

The machine's engine speed is controlled by the engine acceleration dial as well as by a throttle pedal on the floor. To control engine speed via the throttle pedal, apply force to the pedal. Depressing the pedal increases engine speed.

INSTRUMENT PANEL INSTRUMENT PANEL FEAT- URES

The instrument panel consists of the following LCD and switches. The LCD shows the driver the operating condition of the vehicle and any defect status for the correct use and maintenance of the vehicle. Also, it allows for setting various modes, monitoring or other convenience devices and displays their status. Set the machine's operation mode by using switches.

WARNING

- *If a warning lamp comes on in the monitor, check the issues immediately and take necessary actions.*

IMPORTANT

- **The monitor does not guarantee the status of the machine. For safe use of the machine, do not rely only on the monitor. Conduct daily checkup procedures according to Chapter 6: Maintenance.**

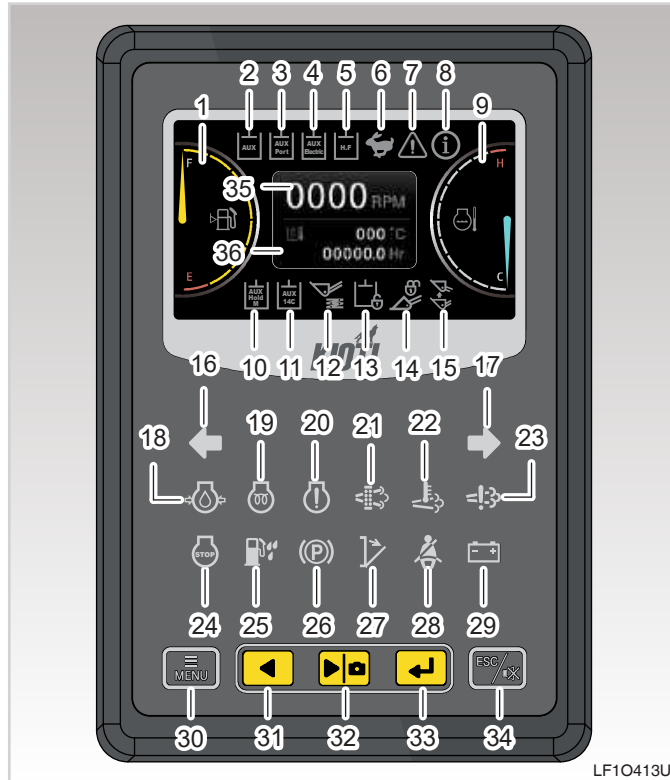

(1) Fuel gauge
(2) AUX. indicator

(3) Auxiliary hydraulic indicator
(4) Auxiliary electric port indicator

(5) High flow indicator
(6) 2-speed lamp
(7) Hazard flasher, High-temperature hydraulic oil warning lamp
(8) Consumables management warning lamp
(9) Engine coolant temp. gauge
(10) Auxiliary hydraulic port indicator
(11) AUX. indicator
(12) Ride control indicator
(13) Hydraulic lock indicator
(14) Quick attachment unlock warning lamp
(15) Self-levelling indicator
(16) Left turn signal indicator
(17) Right turn signal indicator
(18) Engine oil pressure warning lamp
(19) Engine preheat indicator
(20) CHECK ENGINE warning lamp
(21) DPF regeneration warning lamp
(22) DPF regeneration process indicator
(23) Emissions system warning lamp
(24) Engine stop warning lamp
(25) Water-In-Fuel warning lamp
(26) Parking brake warning lamp
(27) Safety cover warning lamp
(28) Safety bar warning lamp
(29) Battery Charge Warning Lamp
(30) Menu switch
(31) Left menu button
(32) Right menu button / Camera button
(33) Enter button
(34) ECS/ Buzzer OFF button
(35) Tachometer
(36) Hour meter

TACHOMETER/HOUR METER

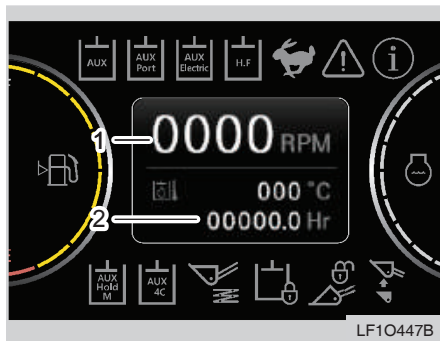

(1) Tachometer
(2) Hour meter

The tachometer indicates the engine rpm. The hour meter cumulates the duration of operation of the engine in hours after it starts

HYDRAULIC OIL TEMPERATURE GAUGE

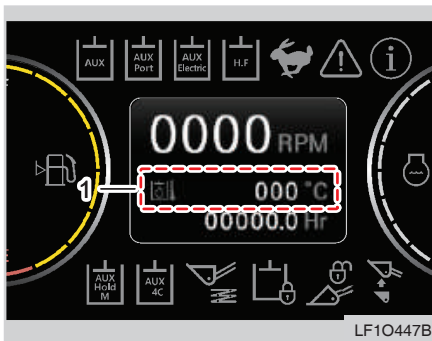

(1) Hydraulic oil temperature gauge

This gauge displays the temperature of the hydraulic oil, and if it exceeds 90°C (194 °F), the warning lamp () will come on and the buzzer will sound. If the lamp comes on, contact a dealer nearby to get it checked.

FUEL GAUGE



(1) Fuel gauge

This gauge indicates the remaining fuel level after the key switch is turned to the "ON" position.

- E: It indicates low fuel (requiring refueling).
- F: Fuel is fully filled.

If driving is continued with the needle below the position "E," air may enter the fuel supply system. In this case, "bleed" the system. (For detailed instructions, refer to "Bleeding fuel system" in the chapter "Maintenance")

ENGINE COOLANT TEMPERATURE GAUGE

! WARNING

- If the level is in red or the fuel level warning lamp light is red on the instrument panel, replenish the fuel immediately.

! CAUTION

- If the level continues to be within the red zone or the warning lamp comes on even after no issues were found, check the electric system as it may be due to the defect in sensors, poor connection of connectors, or the gauge's ground issue.

NOTE

- Make sure to use only clean, ULSD fuel as the engine can be damaged if unqualified fuel is used. (Refer to the page of 6-5)
- Use fuel for winter season in cold weather to start the engine easier.



(1) Engine coolant temp. gauge

This gauge indicates the coolant temperature after the key switch is turned to the "ON" position.

- Amber zone: Low temperature between 55 and 115 °C (131 and 239 °F)
- Red zone: High temperature at 115 °C (239 °F) or over

If the level goes to the red zone or the warning lamp blinks in red and the buzzer sounds while driving, it indicates that the engine is overheated. Reduce the workload immediately.

! CAUTION

- Adjust the workload sufficiently so as to not have the level rise up to the red zone.
- If the level stays in the red zone, do not stop the engine immediately. Instead, reduce the workload to cool down the engine before stopping the engine.

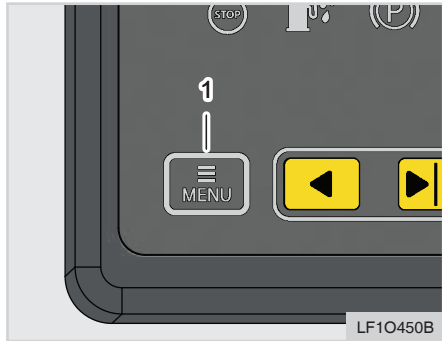
MENU SWITCH*(1) Menu switch*

Press this switch to return to the main menu from the main screen.

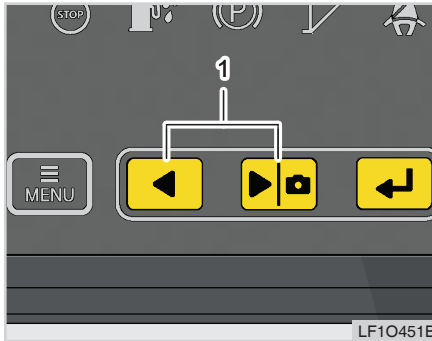
**LEFT/RIGHT MENU SWITCH/
CAMERA SWITCH***(1) Left/right menu switch/camera switch*

Move to the left up or right down in the menu to increase or decrease the input value.

The rear camera mode is displayed from the main screen.

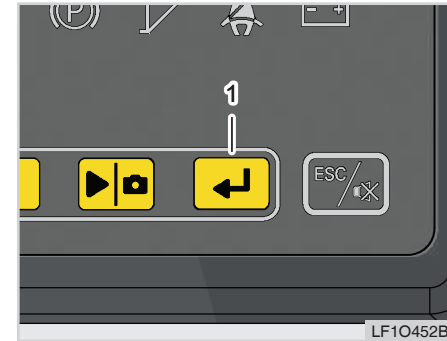
ENTER SWITCH*(1) Enter switch*

Press the Enter switch to display the selected menu.



ESC / BUZZER OFF BUTTON



(1) ESC / Buzzer OFF button

This switch is used to cancel the other menu (move to the previous menu).

The buzzer sounds when the machine malfunctions. At this point, press the switch to stop the buzzer.

HAZARD FLASHER



(1) Hazard flasher

This warning lamp blinks under the following conditions:

- Instrument panel communication data error
- Error code generated
- High hydraulic oil temperature detected (at 90 °C (194 °F) or over)

If the hazard flasher comes on, check for causes and repair immediately.

ENGINE OIL PRESSURE WARNING LAMP

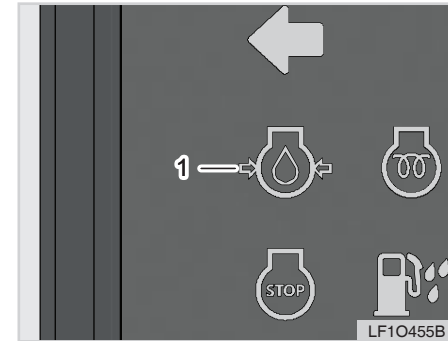

(1) Engine oil pressure warning lamp

This lamp illuminates and the buzzer sounds when the engine oil pressure or oil level is low.

If this lamp comes on while driving, stop the engine immediately and check the engine oil level.

If this lamp comes on and the oil level is within specified operating ranges, have the skid-steer loader checked by your local **KIOTI** dealer immediately.

 **CAUTION**

- If the oil level is below the specified operating range, the engine can stall.
- The engine can be severely damaged if driving or operating the skid-steer loader with the engine oil warning lamp ON.

ENGINE PRE-HEATING INDICATOR

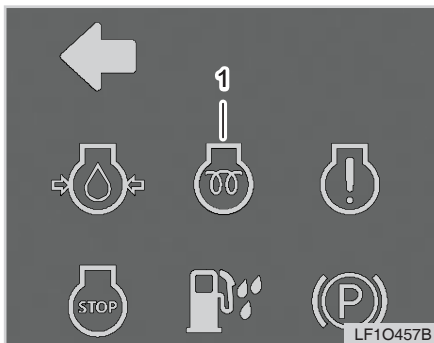

(1) Engine preheat indicator

Once the key switch is on, engine pre-heating starts automatically. Once this indicator is turned off, start the engine.

CHECK ENGINE WARNING LAMP

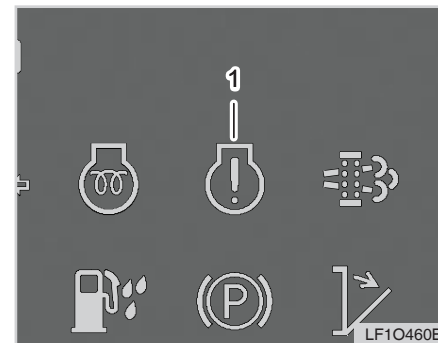

(1) CHECK ENGINE warning lamp

This lamp illuminates to alert the operator of a potential issue with engine operation. If the warning lamp comes on, check for causes and repair it immediately.

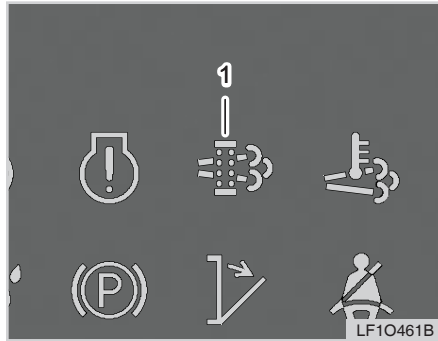
**DPF REGENERATION WARNING LAMP***(1) DPF regeneration warning lamp*

This lamp illuminates according to the regeneration order from the ECU. If this warning lamp comes on, press the regeneration button.

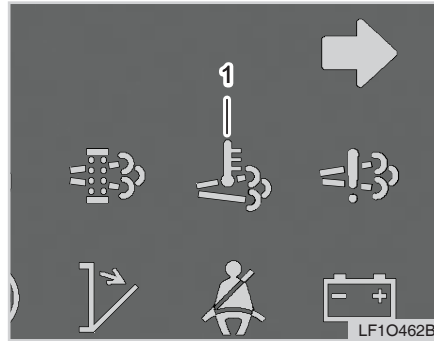
DPF REGENERATION PROCESS INDICATOR*(1) DPF regeneration warning lamp*

Press the DPF regeneration button when the DPF regeneration warning lamp comes on. Then, the DPF regeneration process indicator comes on, and the DPF regeneration process starts.

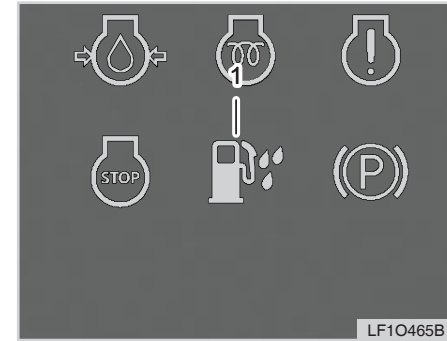
WATER-IN-FUEL WARNING LAMP*(1) Water-In-Fuel warning lamp*

When a certain amount of water is accumulated in the fuel filter, the warning buzzer sounds. In this case, stop the engine immediately and drain water from the fuel filter. (Refer to Chapter 6: Maintenance.)

PARKING BRAKE LAMP

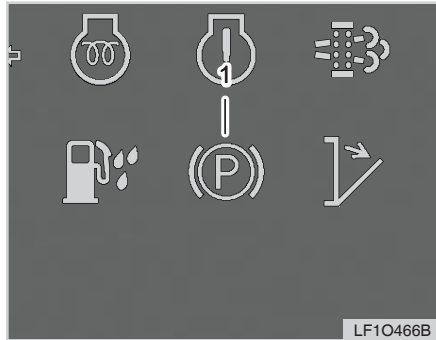

(1) Parking brake warning lamp

When lifting the seat bar after parking, the parking brake is automatically engaged, and the parking brake lamp illuminates. When lowering the seat bar and pressing the hydraulic unlock safety switch, the lamp is turned off.



CAUTION

- If the lamp continues to stay on even after having lowered the seat bar and you have pressed the hydraulic unlock safety switch, have the machine checked at a dealer.

SAFETY COVER WARNING LAMP

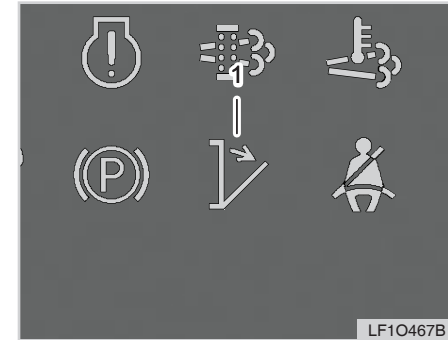

(1) Safety cover warning lamp

This lamp illuminates when the rear radiator door of the engine is open. Under this condition, the engine won't start.



SAFETY BAR WARNING LAMP

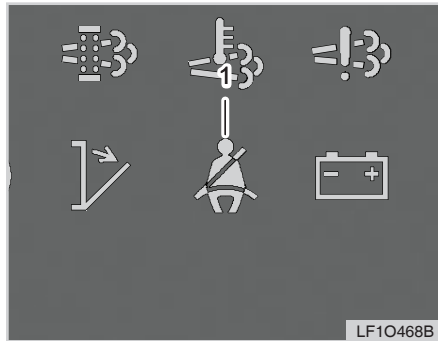

(1) Safety bar warning lamp

This lamp illuminates when the safety bar is lifted.

BATTERY CHARGE WARNING LAMP

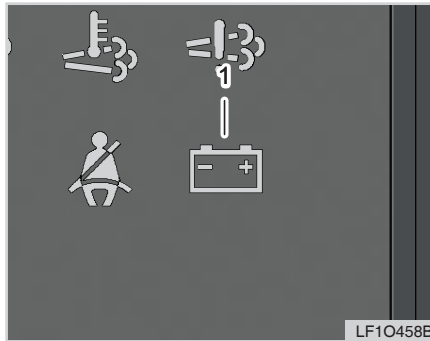

(1) Battery Charge Warning Lamp

This warning lamp illuminates when the battery charging voltage is low. If the warning lamp is on, check the battery charging circuit.



CAUTION

- If this warning lamp comes on while driving, the charging system, such as the alternator, is malfunctioning. Therefore, turn off all electrical devices and have the skid-steer loader checked by your local dealer as soon as possible.

REAR-VIEW CAMERA



- (1) Main screen on the instrument cluster
- (2) Camera switch

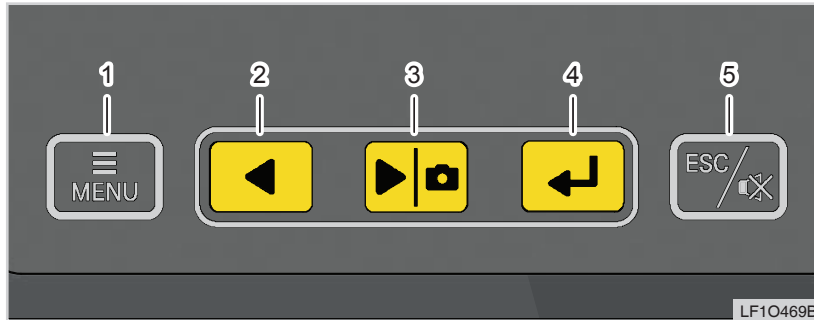

Press the camera switch on the instrument cluster to use the camera function. When the reverse gear-linked function is set to be activated, the rear view is automatically displayed on the main screen when reversing. (for the proper setting, refer to Page 4-43.)

MAIN AND SUB-MENU



- (1) Menu switch
- (2) Left menu button
- (3) Right menu button / Camera
- (4) Enter button
- (5) ECS / Buzzer OFF button

▶ INPUT BUTTONS

No.	Item	Function	Remarks
1	MENU	When pressing this button on the home screen, the sub menu is displayed. When pressing this button on the sub-menu screen, the corresponding item is selected and its input value can be adjusted.	While controlling the function within each sub menu, pressing this button lets you move to the next sub menu.
2	 	The button to select functions and adjust (increase or decrease) input values within the sub-menu	When the camera button is selected, the rear camera image is on regardless of the driving direction.
3		The button to enter the desired function and set input values within the sub menu	
4	ESC / Buzzer OFF	The button to move back to the previous menu screen or to cancel the current function	Press and hold the button to move to the home screen immediately. Press the button while the buzzer sounds to turn the buzzer off.

▶ STRUCTURE

Main Menu	Sub menu	Description
Diagnosis function	<ul style="list-style-type: none"> • Machine condition • Machine information • Current fault 	<ul style="list-style-type: none"> • Displaying coolant temperature, hour meter, RPM, etc. • Displaying instrument panel & MCU version, model name, etc. • Displaying current fault status list of the engine and machine
Maintenance function	<ul style="list-style-type: none"> • Engine start inhibition setting • Consumables management • A/S contact • Administrator menu 	<ul style="list-style-type: none"> • Engine start inhibition setting, password change or password display • Changing oil/filters replacement intervals and checking elapsed time • Displaying and changing A/S telephone number • Displaying fault history and mode change
Configuration	<ul style="list-style-type: none"> • Brightness settings • Time settings • Unit settings • Language settings • Camera settings 	<ul style="list-style-type: none"> • Brightness manual/automatic (day, night) settings • Current time settings • Temperature (°F/°C) • Korean, English • Reverse gear-linked function ON/OFF

 Press the menu button to activate the sub-menu.

▶ DIAGNOSIS FUNCTION

① Machine status

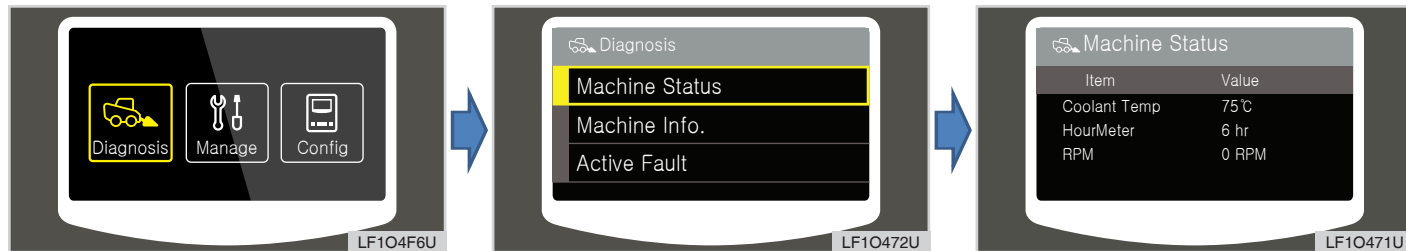

4

☞ The status of the machine is displayed.

② Machine information

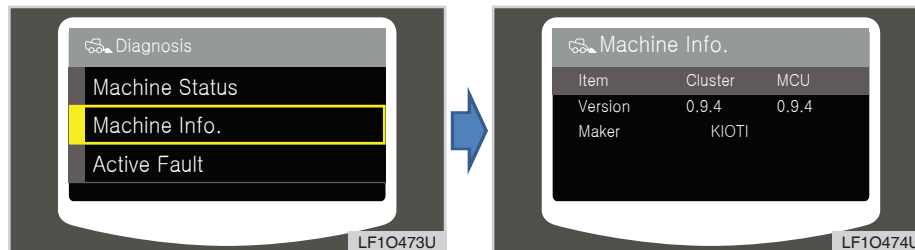

☞ You can check the version of the instrument panel and MCU as well as the machine's model name.

③ Current fault

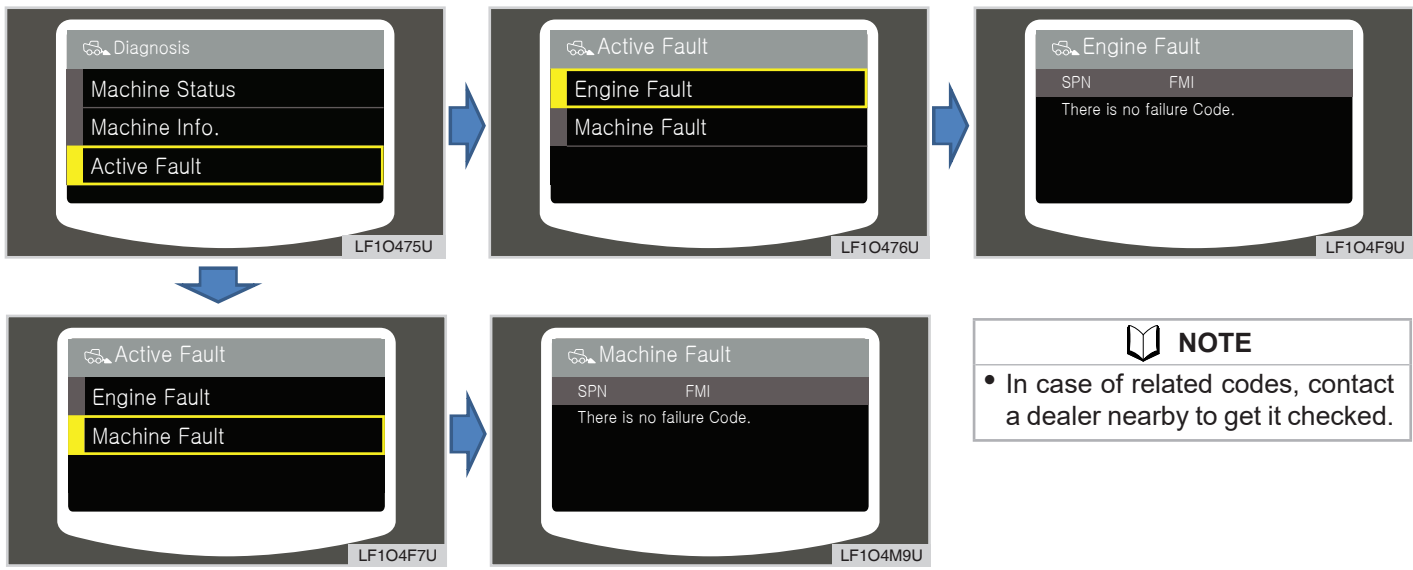

NOTE

- In case of related codes, contact a dealer nearby to get it checked.

☞ You can check the current fault of the engine and machine.

▶ MAINTENANCE FUNCTION

① Password protection setting

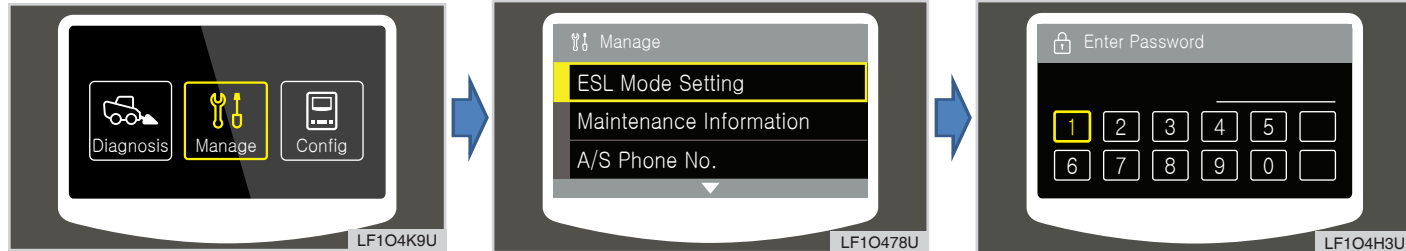

☞ Password protection setting

- The password protection function is designed to prevent theft and unauthorized use of the machine.
- While the password protection setting is set to ON, the system requires a password when the key switch is turned on.
- OFF: the password protection setting function is not deactivated.
- ON: whenever an operator tries to start the engine, the preset password needs to be entered.
- ON after preset time: whenever an operator tries to start the engine, the preset password needs to be entered. However, when the operator tries to start the engine within the preset time, the password is not required. The preset time can be set up to two days.
 - ※ Default password: 00000
 - ※ Length of the password: 5~10 digits

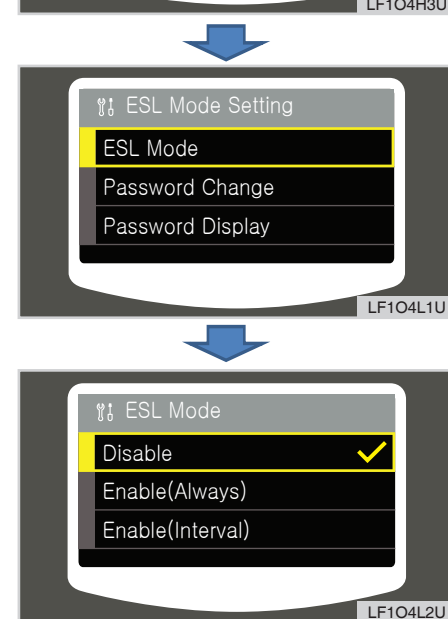

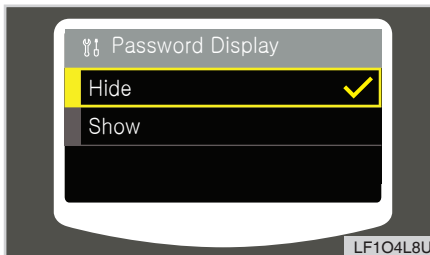
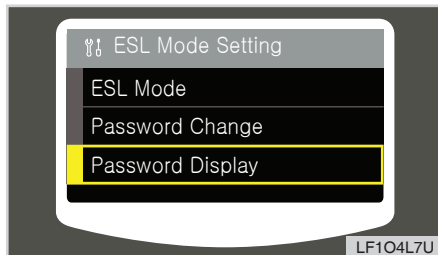
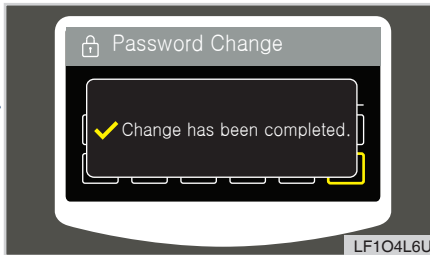
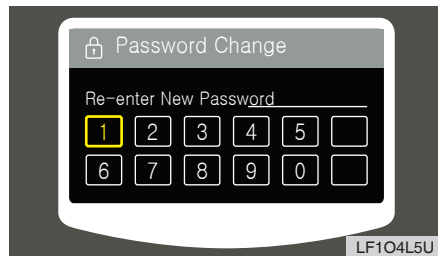
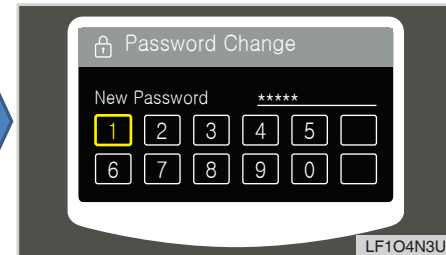
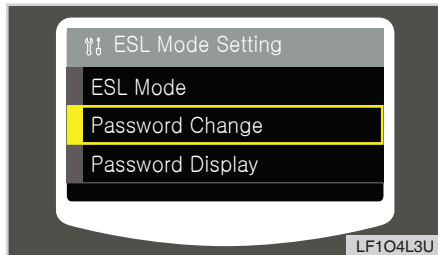

☞ Password change / password display

- A password is 5-10 digit long.
- Password change: Enter the current password → Enter a new password → Re-enter the new password → Password change is completed.
- Password display: Setting of hiding/ displaying the password
- Default password: 00000

② Consumables management

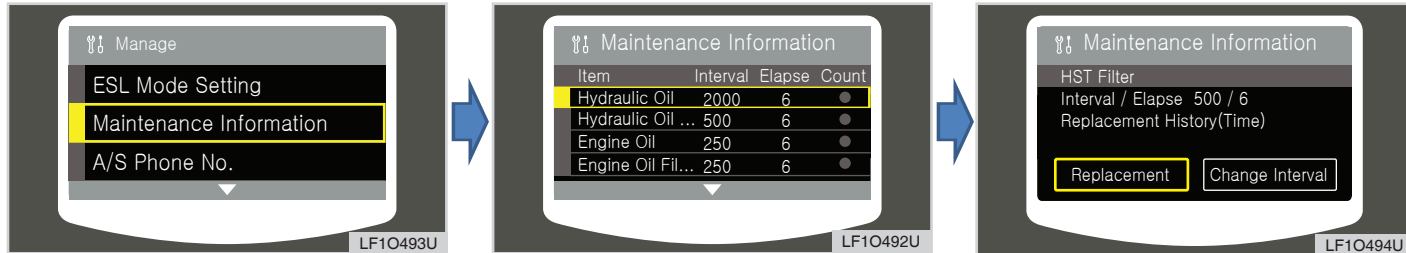

4

- ☞ Elapsed time: it shows the elapsed time after the maintenance.
- ☞ Replacement interval: the replacement interval can be incremented/decremented in 50 hours.
- ☞ Replacement frequency: it shows the maintenance replacement history.
- ☞ Replacement: the elapsed time is reset to 0.

③ A/S contact

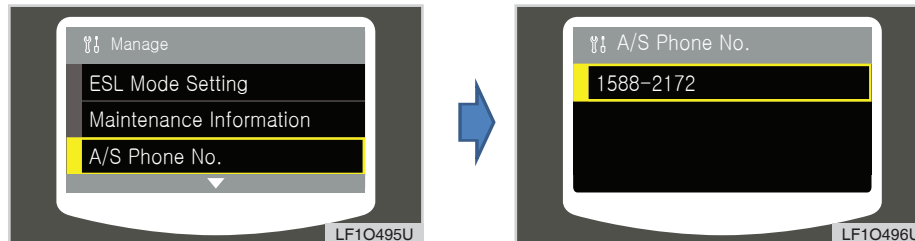

- ☞ You can check and change the A/S contact details.

④ Hydraulic control

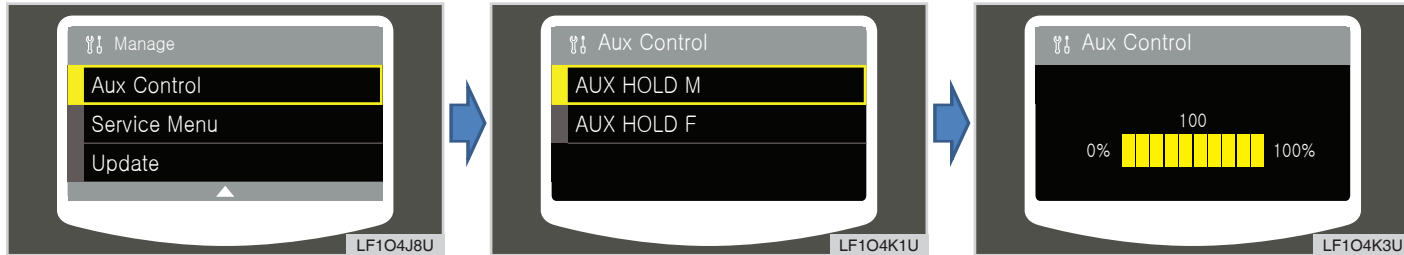

☞ Hydraulic control: The amount of hydraulic flow delivered to the external hydraulic attachment can be controlled.

☞ AUX HOLD M : The amount of flow sent to the male coupler can be set by percentage, using the ◀, ▶ buttons in the instrument panel.

☞ AUX HOLD F: The amount of flow sent to the female coupler can be set by percentage, using the ◀, ▶ buttons in the instrument panel.

- Press the auxiliary hydraulic pressure supply button to continue to supply the set hydraulic pressure.
- When supplying hydraulic pressure via the jog dial, the amount of flow increases as the dial turns from the center towards the end. The maximum possible flow is supplied based on the value set by the jog dial (ex: the maximum value is 50% when 50% is set by the jog dial).
- When controlling the flow by jog dial, turning it to the left supplies the hydraulic pressure to the male coupler, and turning it to the right supplies the hydraulic pressure to the female coupler.



► CONFIGURATIONS

① Brightness settings

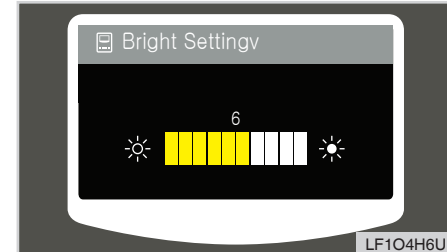
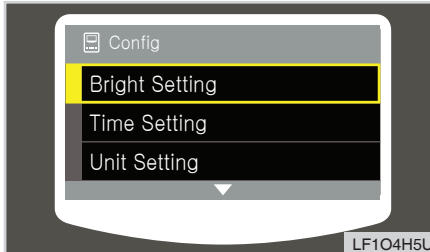

4

- ☞ Manual: The LCD brightness can be set manually.
- ☞ Automatic: The LCD brightness is automatically controlled according to the setting level for daytime/nighttime.
- ☞ Daytime duration setting: The daytime duration can be set. Once the duration for daytime is set, the remaining duration corresponds to the nighttime.

② Time settings

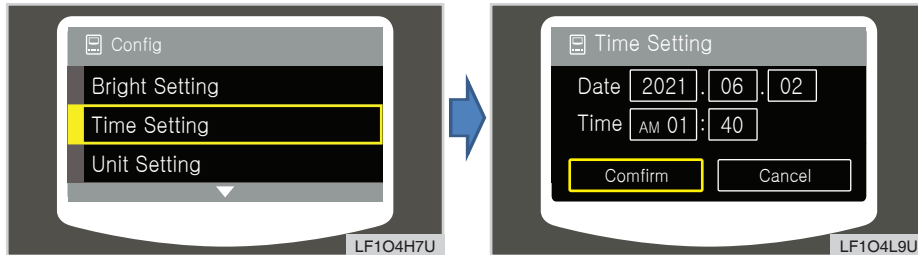

☞ The time can be set. (Year, Month, Day, Hour, Minute)

③ Unit setting

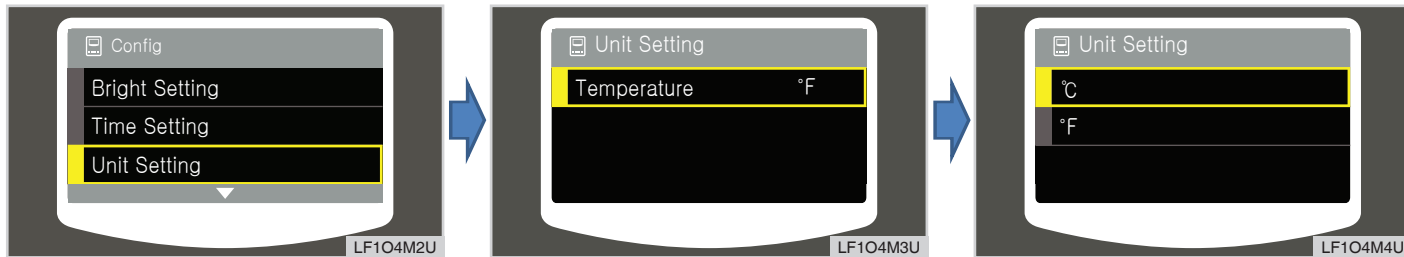

☞ Temperature: Celsius (°C)↔ Fahrenheit (°F)



④ Language settings

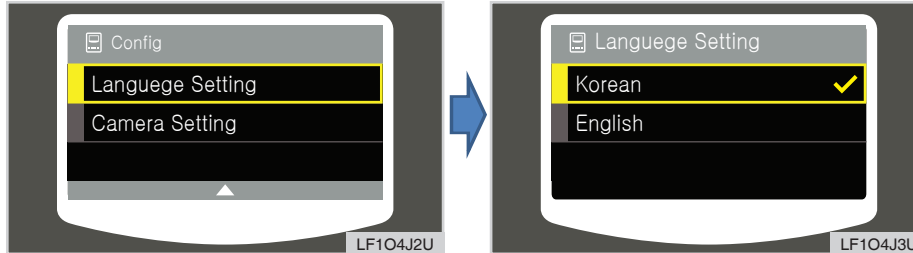

☞ The desired language can be selected. Once a language is selected, all information is displayed in that language.

4

⑤ Camera settings

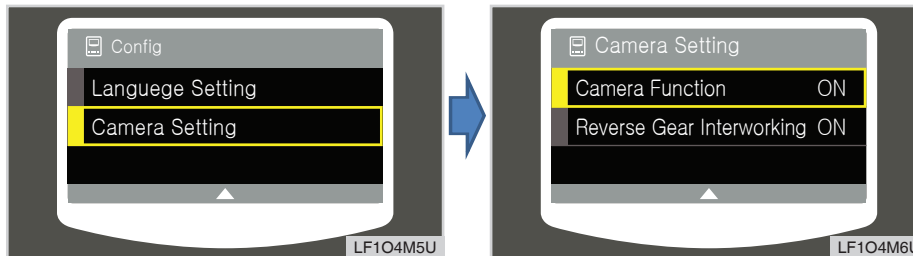

☞ You can set the camera function on or off (optional).

☞ You can turn the reverse gear linked function on or off.

☞ Reverse gear linked function: When the vehicle is in reverse, the camera mode is automatically displayed on the main screen.

MACHINE DIAGNOSIS CHECKING THE MONITOR



1. Check if the  or  warning lamp is illuminated on the monitor.



2. Press the MENU button.



3. Press the Enter button () to select the 'Diagnosis' function.



4. Press the Enter button () to select the "Active fault".



5. Press the Enter button () to select the "Machine fault".



6. Check the code and press the Enter button ().

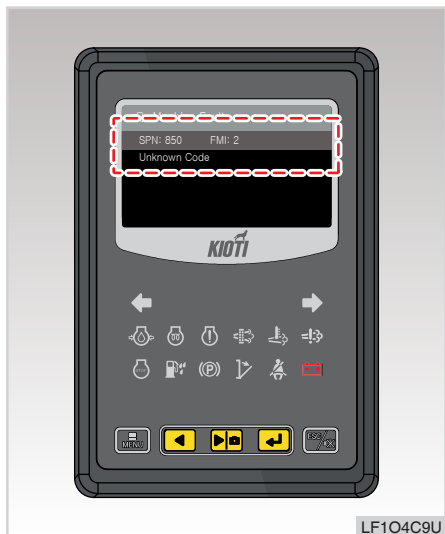

7. Verify and check the diagnosis details.

▶ FAULT CODES LIST(FOR MACHINE)

No.	DTC		Description	Part that might have failed
	DDSPN	FMI		
1	101	3	Voltage of the oil temperature sensor and its wiring is higher than normal or they are shorted.	Oil temperature sensor, Oil temperature sensor wiring
		4	Voltage of the oil temperature sensor and its wiring is lower than normal or they are shorted.	
2	301	3	Voltage of the fuel sender circuit is higher than normal, or the circuit is shorted to high voltage or open	Fuel sender Fuel sender wiring
		4	Voltage of the fuel sender circuit is lower than normal, or the circuit is shorted to low voltage	
3	705	0	High battery voltage	Battery Battery wiring
		1	Low battery voltage	
4	707	1	Alternator voltage is low or open.	Fuse (R terminal power), alternator or wiring
5	841	2	ECU communication error	ECU/MCU/Cluster/Wiring

※ refer to page 8-5.

NOTE

- In case of related DTC codes, contact a dealer nearby to get it checked.



CABIN & CANOPY INTERIOR DEVICES (CABIN MODEL ONLY)

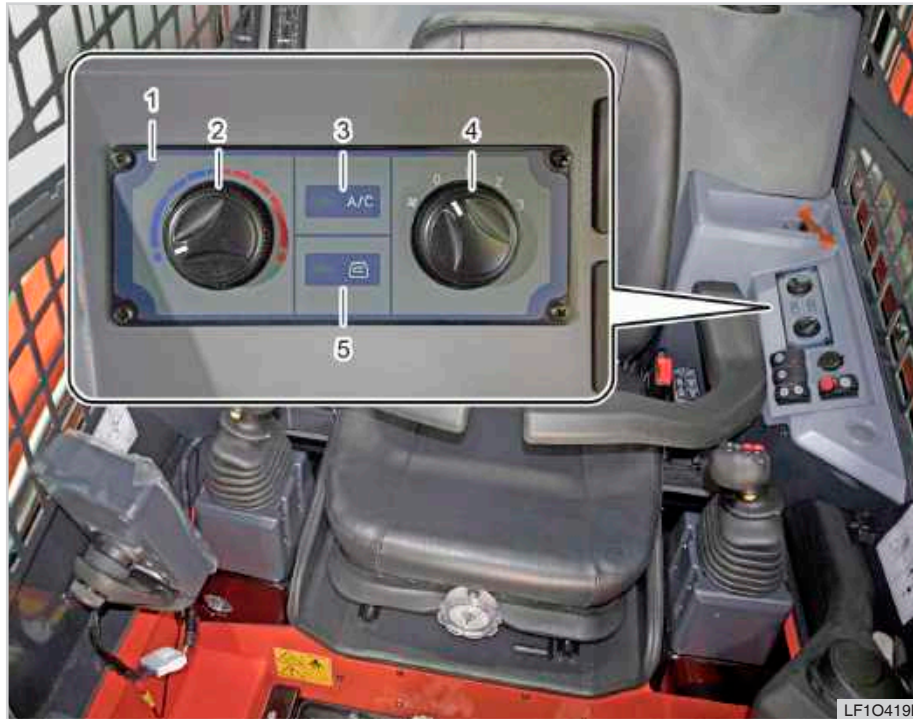

- (1) Heater / A/C controller
(2) Temperature control dial
(3) A/C power button

- (4) Fan speed control dial
(5) Air recirculation switch

EXTERIOR DEVICES



- (1) Wiper (Cabin) (2) Work lamp
(3) Turn signal lamp
(4) Handle (Cabin) (5) Door lock (Cabin)

1. The cabin&canopy was designed to offer a comfortable and convenient working environment.
2. With the A/C and heater, a pleasant indoor environment can be maintained in the cabin.
3. The ROPS (RollOver Protection Structure) certified cabin&canopy structure improves your safety. However, operator safety degrades drastically if the operator does not wear the seat belt.

DOOR (CABIN MODEL ONLY)

(1) Door lock (2) Handle

Press the door button to lift and raise the door. To close the door, use the handle to lower the door.

The door can be locked with the ignition key by inserting the key into the lock on the door button and turning the locking device.

DOOR STOPPER (CABIN MODEL ONLY)

(1) Door Stopper, RH (2) Handle (Lock Pin), RH (3) Door Stopper, LH (4) Handle (Lock Pin), LH (A) Lock

Door stoppers are installed on the left and right sides to work with the door open.

To lock the door, push the handle of each of door stopper to the left or right with the door open.

CAUTION

- **When driving with the door open, be sure to securely fix the door with the door stopper before driving. Otherwise, there is a risk of damage to the door or glass and personal injury.**

WORK LAMP

(1) Work Lamp (front)

The work lamp is installed on the front and rear of the cabin roof, and the button is attached on the right panel inside the cabin.

Press the "ON" section of the work lamp switch (front/rear) to turn on the work lamp.

At this point, the key switch should be in the "ON" position.



WIPER (CABIN MODEL ONLY)



(1) Wiper
(2) Wiper switch

1. While the key switch is on, press the "ON" section of the wiper switch (front/rear) to turn on the wipers.
2. While the wiper switch is "ON", press it again to have the washer fluid sprayed from the nozzles connected to the window brushes.



(1) Washer fluid reservoir tank

3. The washer fluid reservoir tank for cleaning the windshield is installed on the right side of the driver's seat in the rear of the cabin.

WARNING

- *It is advised to use washer fluid exclusively for automobiles. In particular, make sure to use the washer fluid for automobiles (for winter season) in winter.*

WARNING

- *If you keep trying to spray the washer fluid with the washer fluid reservoir tank empty, the washer fluid motor will be damaged. Therefore, make sure to check the washer fluid level before operating.*
- *In case of dirt on the windshield, spray a sufficient amount of washer fluid when using the wipers. In winter, using the wipers on the frozen windows may cause blown fuses. In this case, raise the cabin interior temperature and use the wipers.*

ANTENNA



LF1O427A

(1) Antenna

NOTE

- If the radio signal reception is poor, check the antenna connection and angle.

INTERIOR LAMP

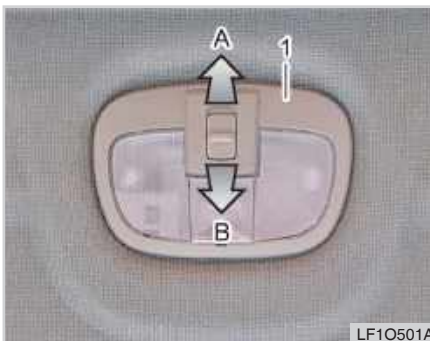

LF1O501A

(1) Interior lamp

Turn on the interior lamp by turning the interior lamp switch to "ON". Place the switch to AUTO to have the interior lamp turned on and off automatically.

CAUTION

- The interior lamp can be operated without the key inserted. If the interior lamp is left on for a long time, it may cause the battery to be discharged.

ACCESSORIES POWER SOCKET & USB SOCKET



LF1O405A

CANOPY



LF1O4Q7A

(1) Power socket

(2) USB socket



The power socket and the USB socket are activated when the ignition key is turned to "ON".

If these sockets are used for a long time when the engine is off or an electric products with excessive capacity is used on the sockets, the battery may be discharged.

CAUTION

- **If emergency power is needed, the power socket can be used. In this case, do not exceed 12V, 100W.**

CUP HOLDER AND STORAGE SPACE



(1) Cup holder (2) Storage space

The cup holder and storage space are located on the left and right side of the operator's seat.

RADIO & USB PLAYER (CABIN MODEL ONLY - OPTIONAL)

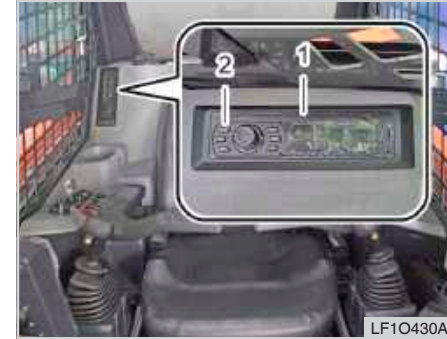

(1) Radio speakers with bluetooth
(2) Power (PWR) switch

This vehicle is equipped with a Bluetooth player which has an audio/radio function and wireless LAN communication. Using the Bluetooth function, it is possible to pair and use it with other Bluetooth enabled devices. For detailed information, refer to the stereo system's user manual.

HEATER AND A/C (CABIN MODEL ONLY)

 CAUTION

- Working with the volume of the stereo system excessively high can affect the driver's concentration, leading to possible safety accidents.

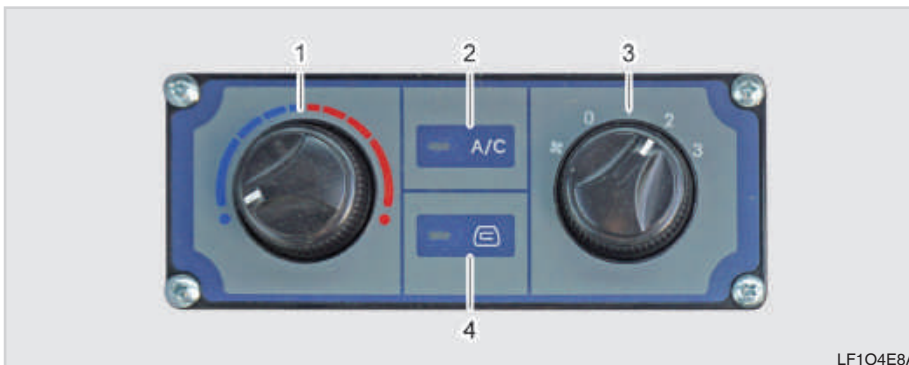

(1) Temperature Control Dial
(3) Blower Speed Control Dial

(2) A/C Switch
(4) Air Recirculation Switch

Use the A/C only after the engine is started.

 WARNING

- Use fresh air mode under normal conditions. The recirculation mode should be used during extremely dusty conditions or periods when the cabin has been open or exposed to excessive heat and rapid cooling is required. For the remainder of the time, fresh air mode should be used.

**BLOWER SPEED CONTROL DIAL**

The heater or A/C blower speed is controlled in four steps.

A/C SWITCH

Press the A/C switch once to run the A/C and press it again to turn it off. The heater is controlled by the temperature control dial and blower speed control dial.

TEMPERATURE CONTROL DIAL

Use this dial to obtain the desired temperature. Turn it to the right (red) for warm air and to the left (blue) for cool air.

The temperature control dial only controls the blower speed of the air passing through the heater or the A/C. Therefore, if setting it to high temperature with the A/C on, unnecessary load may be applied to the A/C.

⚠ WARNING

- *Operating the machine for long periods under stationary conditions with high hydraulic loading and A/C operation could lead to engine overheating. Use caution and pay close attention to the engine temperature gauge when performing operations like hammering, grinding or drilling in stationary conditions (the machine is not moving) during hot conditions with the A/C operational.*

⚠ CAUTION

- **Close all windows when using the A/C for effective cooling.**
- **Even in winter when the A/C is not used, run the A/C 1-2 times every month to promote compressor lubrication, resulting in lengthening the service life of A/C parts.**

A/C MAINTENANCE

To maintain the optimal condition of the A/C, please keep the followings:

1. Operation in winter:

In winter, make sure to run the A/C 1-2 times every month to promote the compressor lubrication so as to prevent any malfunctioning in advance.

The A/C does not work if the air temperature is at 2°C (35.6 °F) or below. Run the heater to increase the cabin temperature before use.

2. A/C condenser cleaning:

Impurities in the A/C condenser or engine radiator may reduce cooling efficiency and should be removed. Clean them using a soft brush or a water hose and be careful not to bend the core of the condenser.

3. Operation in summer:

Before the summer season, make sure to check the A/C belt tension to ensure proper use of the A/C in summer.

⚠ CAUTION

- **Using an unauthorized refrigerant or compressor oil may cause severe damage to the A/C system.**
- **Insufficient refrigerant reduces the A/C performance, but excessive refrigerant also damages the A/C system. In case of any malfunction, have it checked by a dealer.**

**A/C REFRIGERANT AND LUBRICANT SPEC.**

Item	New re- frigerant type	Compressor oil
Type	R134a	PAG 46
Capacity	600g	150 cc

⚠ WARNING

- *Have the A/C serviced by a specialist. Any unauthorized repair or service may lead to personal injuries and other accidents due to the high-pressurized refrigerant.*

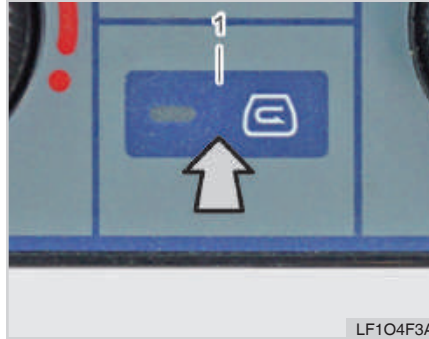
AIR RECIRCULATION MODE AND FRESH AIR MODE

(1) Air recirculation switch

While the A/C is running, the air recirculation mode or fresh air mode can be selected as desired.

Even if the air recirculation mode is selected, introduction of external air cannot be completely prevented.

If the fresh air mode is selected, 100% external air is introduced to the cabin.

⚠ WARNING

- *The cabin in this machine is not designed, engineered or certified with filtration for operations requiring a spray certified cabin or operation in conditions where exposure to unfiltered chemicals or pollutants could cause injury or harm to operators.*

ADJUSTING THE SEAT SEAT ADJUSTMENT



(1) Seat Adjustment Lever
(A) Pull

To adjust the seat position, pull up the lever under the front of the seat, slide the seat to the desired position (F/R 150 mm), and then release the lever. Make sure that the seat is firmly fixed by moving it gently after adjustment.

⚠ CAUTION

- Do not put a hand between the seat and the slides when adjusting the seat position. You can get injured unexpectedly.

CUSHION STRENGTH ADJUSTMENT



(1) Seat Cushion Adjustment Lever

The seat cushion can be adjusted according to the weight of the driver. Turning the cushion adjustment lever counterclockwise to the 50 kg position makes the cushion lighter, and turning the lever clockwise to the 120 kg position makes the cushion heavier.

SEAT BAR



(1) Seat bar

If the seat bar is raised, operating the control lever even with the engine running does not cause the machine to move.

Raising the seat bar engages the parking brake. Lowering the seat bar and pressing the hydraulic unlock safety switch releases the parking brake.

When leaving the cabin, make sure to comply with the followings:

- Make sure that joystick control levers are always in neutral.



- Do not place objects on the operator's seat.
- Place the key switch to "OFF".
- Raise the seat bar.
- Carefully leave the cabin while holding the handle.

SEAT BELT



(1) Seat belt
(A) Release

(2) Release button

The seat belt is a self-retracting type. Make sure to fasten the seat belt before operating.

WARNING

- *To prevent accidents, operate the machine only after wearing the seat belt.*
- *Before use, make sure to always check for any defect in the seat belt.*

WARNING

- *Make sure that the seat belt is not twisted. It cannot work properly, leading to a dangerous situation.*
- *The seat belt should go around your body as low as possible, not your waist or abdomen.*

MCU (MACHINE CONTROL UNIT)



(1) MCU (Machine Control Unit)
(2) Lamp

It controls various lamps and buzzers by receiving signals from the switches, engine and hydraulic pressure sensors.

LED SPEC.

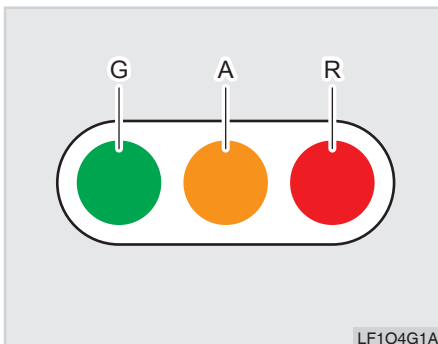

(G) Green (A) Amber
(R) Red

<Error and check items by LED indication>

Lamp status			Status
Green	Orange	Red	
ON	OFF	OFF	Normal
OFF	OFF	ON	Faulty CPU
ON	ON	OFF	Faulty communication
OFF	OFF	OFF	No power

EMERGENCY EXIT



(1) Emergency exit tag

The front exit and the rear window are designed as emergency exit.

To exit through the rear window, please do the following:

- Pull the tag on the rear window to pull out the core seal that fixes the window.
- Push out the window to exit.



MANUAL QUICK ATTACH SYSTEM

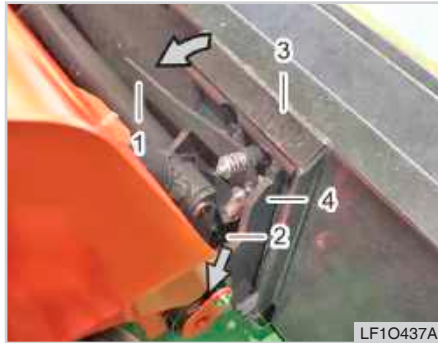

(1) Hand lever (2) Locking pin
(3) Bucket slot (4) Attachment holder

1. Park the vehicle on even ground and pull up the both hand levers on the attachment holder (quick coupler). (Unlocked)
2. Place the attachment holder (quick coupler) right behind the bucket.
3. Lean the attachment holder forward and move the machine toward the bucket so that the rear of the holder goes under top lip of the bucket.
4. Tilt the attachment holder lean back to align the plates flat together.

5. Lower the engine speed and raise the seat bar.
6. Carefully remove yourself from the machine using the handle.
7. Push down the hand lever and check that the locking pin went completely into the bucket slot (Locked).

REMOVING THE BUCKET (MANUAL TYPE)



(1) Hand lever (2) Locking pin
(3) Bucket slot (4) Attachment holder

1. Pull up the hand lever of the attachment holder and check that the locking pin is out from the bucket slot. (Unlocked)
2. Using the handle, enter the cabin. Lower the seat bar and increase the engine speed.
3. Lean the attachment holder forward and move the machine backward so that the top of the holder is removed from the bottom of the top lip of the bucket.

INSTALLING AND REMOVING THE BUCKET (HYDRAULIC QUICK ATTACH SYSTEM)



(1) Quick attachment switch



(1) Removable cylinder

1. While the engine is running, park the machine on even ground.
2. Place the attachment holder (quick coupler) right behind the bucket.
3. Lean the attachment holder forward and move the machine toward the bucket so that the rear of the holder goes under top lip of the bucket.
4. Tilt the attachment holder lean back to align the plates flat together.
5. Press the quick attachment switch to operate the removable cylinder, then the locking pin goes into the bucket slot automatically.
6. Raise the seat bar and get off from the machine. Check if the bucket is attached correctly.
7. To remove the bucket, place the bucket on even ground, and press the quick attachment switch to pull out the locking pin from the bucket slot.
8. Lean the attachment holder forward and move the machine backward so that the top of the holder is removed from the bottom of the top lip of the bucket.

BOOM LOCK



(1) Boom lock (2) Locking pin



CAUTION

- To safely and properly install or remove the boom lock, two (2) people are required. One (1) person is the machine operator while the second person installs/removes the lock before the operator exits the machine.



1. Remove the two (2) attaching bolts from the boom lock. Next remove the snap pin connected to the boom lock and remove the boom lock from its storage location. The helper who will install the boom lock should now step at least three feet away from the machine and position themselves so they can speak to the operator through the left side window.



(1) Boom lock
(3) Snap pin

(2) Lift arm cylinder

2. The operator should follow these steps next:

- 1) Open the LH window and acknowledge the helper who will be installing the boom lock.
- 2) Buckle the operator's seat belt.
- 3) Lower the operator restraint bars and start the engine.
- 4) Inform the helper to wait for your confirmation before proceeding with the boom lock installation.
- 5) Release the park and raise the lift arm to full height, remove both hands from the controls, engage the park function and turn the engine off.
- 6) Inform the operator to install the boom lock and await for confirmation.
- 7) The helper should install the narrow end of the boom lock upward covering the cylinder rod and insert the snap pin. The wide end of the boom lock should face downward and rest against the base of the cylinder body.

RELEASING THE LIFT ARM

- 8) With confirmation that the boom lock has been installed make sure the helper has stepped away from the machine and is visible.
- 9) Turn the ignition on but do not start the engine, release the park and lower the lift arm slowly till it rests against the stop.
- 10) Engage the park function and turn the ignition off.
- 11) Request the helper to perform a visual inspection to confirm the boom lock is properly installed.
- 12) With confirmation, remove the key from the ignition, raise the operator restraint bars, release the seat belt and exit from the cabin.



(1) Boom lock (2) Locking pin
(3) Lift arm cylinder rod



CAUTION

- To safely and properly install or remove the boom lock, two (2) people are required. One (1) person is the machine operator while the second person installs/removes the lock before the operator exits the machine.
- The helper who will remove the boomlock should now step within three feet from the machine and position themselves so they can speak to the operator through the left side window.

1. The operator should enter the machine, install their seat belt, lower the operator restraint bars and acknowledge the helper
2. Inform the helper that you will start the machine now and not to approach the machine until you provide confirmation
3. Start the machine and release the park function. Raise the lift arm to



RAISING THE CANOPY AND CABIN

full height and remove both hands from the controls, engage the park function and turn the engine off

4. Inform the helper to remove the boom lock
5. With confirmation the boom lock has been removed and with the helper visible, turn the ignition on (DO NOT START THE ENGINE), release the park function and slowly lower the lift arm to the ground.
6. Engage the park function, turn the ignition off, raise the operator restraint bars, release the seat belt and exit the cabin.
7. Install the boom lock in its storage position. Be sure to tighten the two (2) securing bolts and to install the snap pin.
8. Perform a visual inspection to be sure all work has been completed and all tools have been stored.
9. Remove the wheel chocks.
10. The machine should be ready to return to work.



(1) Bolt

(2) Washer

1. Stop the machine on even ground and lower the lift arm.
2. Loosen the mounting nuts on the left and right of the front cabin.



CAUTION

- When raising the cabin or the lift arm for maintenance, install a jack stand behind the frame so as to prevent the vehicle from falling backward.
- If the jack stand is not installed behind the frame of the machine, the machine may fall back.

LOWERING THE CANOPY AND THE CABIN



(1) Lock

3. Raise the cabin slowly and fix it with the lock on the back.



(1) Snap pin
(A) Loosen

1. Pull out the snap pin and take out the locking pin from the frame.
2. Lower the cabin slowly.

(2) Locking pin



(1) Bolt

2. Install the washers and bolts on the left and right of the front side of the cabin.

(2) Washer



TIRES

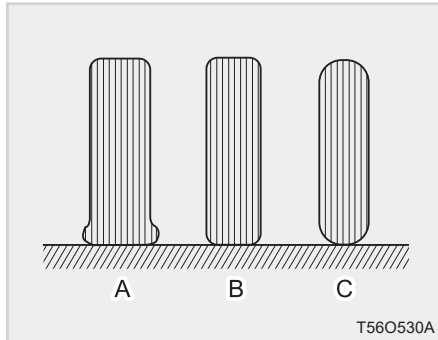

(A) Insufficient
(C) Excessive

(B) Standard

Though the tire pressure is factory-set to the prescribed level, it naturally drops over the course of time.

Thus, check it everyday and inflate as necessary.

WARNING

- Do not use tires larger or smaller than specified.
- Do not disassemble or assemble the tire. If it is necessary to disassemble/assemble the tire, let a qualified service personnel perform the work.



4

WARNING

- The tire rims can fall out of the tires. Therefore, stay out of their way when checking or inflating tires.

TIRE INFLATION PRESSURE

Always maintain the proper tire inflation pressure. Make sure the tire pressure does not exceed the pressure recommended in the manual.

Turf tire		
Item	Tire size	Inflation pressure
1	12-16.5-12PR	5.25 kgf/cm ² 514 kPa 75 psi
2	10X16.5-8PR	3.87 kgf/cm ² 380 kPa 55 psi

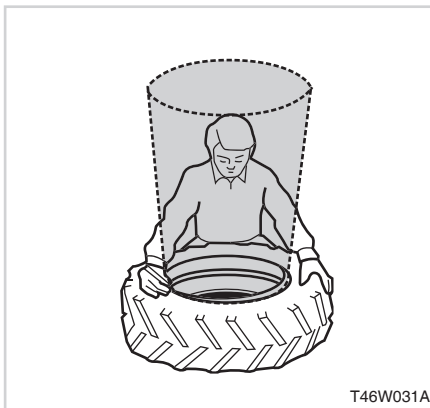

⚠ WARNING

- **Do not weld or apply heat to the tire rim or disc. The tire can explode due to the rapidly increased pressure in the tire.**
- **Check tires for inflation pressure, damage, deformation, and excessive wear on lug and damage of rim and disc. Also check if wheel bolts, rim bolts, and nuts are loose.**

WHEEL TORQUE WHEEL INSTALLATION

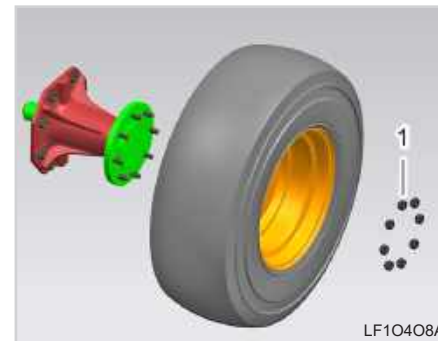

(1) Wheel nut

Turf tire

Item	Tire size
1	12-16.5-12PR
2	10X16.5-8PR

Tightening torque of wheel Nut

196~225 N·m
144~166 lbf·ft
20 ~ 23 kgf·m



 **WARNING**

- *Assemble the tire as shown in the figure.*
- *Contact your local KIOTI Dealer if it is necessary to change the tire specification or installation method.*

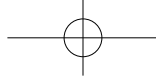

MEMO





DRIVING INSTRUCTIONS

5

PRE-OPERATION CHECK	5-2	OPERATION	5-16
INITIAL OPERATION	5-2	FILLING THE BUCKET	5-16
OPERATING THE ENGINE	5-3	DIGGING	5-17
STARTING ENGINE	5-3	LEVELING	5-18
STOPPING ENGINE	5-6	FLOAT	5-18
WARMING UP	5-7	DUMPING	5-19
JUMP STARTING	5-7		
DRIVING AND OPERATION	5-8		
OPERATION BEFORE DRIVING	5-8		
FORWARD AND REVERSE DRIVING....	5-10		
TURNING	5-11		
DRIVING ON SLOPES	5-11		
PRECAUTIONS WHILE DRIVING ON THE ROAD	5-13		
LOADING AND UNLOADING THE MA- CHINE TO/FROM A TRUCK	5-14		
LIFTING THE MACHINE	5-15		



PRE-OPERATION CHECK

It is a good practice to know the condition of your machine before you start it. You should do a routine check before each use.



CAUTION

- **Park the machine on level ground, stop the engine, and apply the parking brake before checking or repairing it.**
- **Refer to “Daily check item” in the “Maintenance Chapter” for fueling.**
- **Be sure to read and understand the information titled as “DANGER”, “WARNING”, and “CAUTION” thoroughly for the safe operation.**

CHECK ITEMS

- Walk around inspection.
 - Engine oil level.
 - Hydraulic oil level.
 - Coolant level.
 - Clean the front grill and radiator screen.
 - Air cleaner element.
 - All dash gauges and indicators.
 - Head lights, tail lights, and working lights.
 - Accessible wiring harness for any damage.
 - Seat belt and cabin for damage.
 - Fuel level.
 - All “DANGER” and “WARNING” decals.
 - Tire pressure and wheel bolt tightness condition.
 - Bucket locking status (Safety)
- For detailed information, refer to “Maintenance schedule chart” in chapter 7.

INITIAL OPERATION

Driving a new machine at a high speed or under heavy load can affect its durability.

Make sure to run the machine at the proper work load and speed for the initial operation of 10 to 100 hours.

TIPS FOR BREAKING-IN

1. Start the engine and idle the engine at a low speed for 3 to 4 minutes in advance.
2. When breaking in a new machine, do not use the machine excessively, but operate it in the following three steps.

Operation hours	Load
Up to 10 hours	60%
Up to 100 hours	80%
After 100 hours	100%

3. Increase the idling time in cold weather.



OPERATING THE ENGINE STARTING ENGINE

4. Do not drive the machine at the maximum speed on a road.
5. Never apply excessive load during work.
6. Idle the engine at a low speed for 2 to 3 minutes before stopping it.

WARNING

To avoid accidents:

- *Be sure to read and understand the warning and caution decals on the machine thoroughly.*
- *Run the engine only in a well-ventilated area, to avoid excessive exposure to exhaust gas.*
- *Never start the machine unless you are seated in the driver's seat with the operator restraints lowered and the seat belt fastened. Failure to follow these guidelines could cause injury or damage to the machine or property.*

CAUTION

- Do not start the engine unless the seat bar is lowered. If the seat bar is not lowered, it may lead to an accident.
- Do not start the engine if “No Operation” tag is attached on the key switch or control lever.

IMPORTANT

- Using an additive so the engine will start more easily can damage the engine. And it will not be covered by warranty.
- Never try to start the engine for over 10 seconds consecutively to protect the start motor and battery from damage.



(1) Joystick control levers
(A) Seat bar

1. Make sure there is no obstacle around the machine.
2. Check if the control lever and pedal are in neutral, then lower the seat bar.



(1) Parking switch

3. Press the parking switch to put the machine into the parked state.

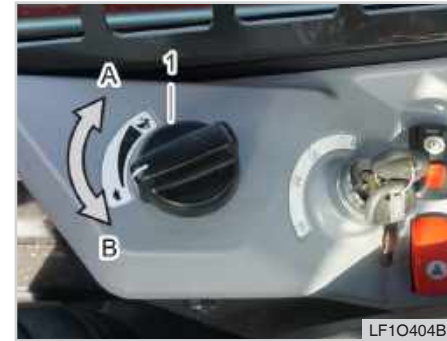

(1) Engine acceleration dial
(A) Acceleration (B) Deceleration

4. Turn the engine acceleration dial to low speed, idling position.

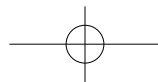

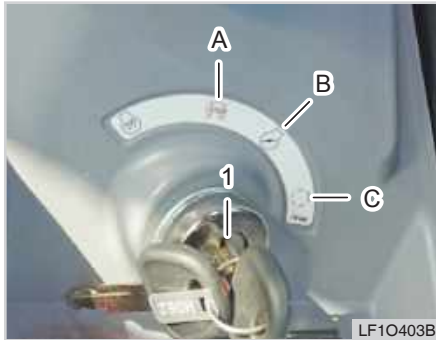

(1) Key switch

(A) OFF

(B) ON

(C) START

5. Insert the key to the key switch and turn it "ON". Once the engine pre-heating indicator is turned off, turn the key switch to the START position start the engine. (The engine can start only when (**P**) lamp on the instrument panel is turned on.)

⚠ WARNING

- **Never operate the start motor for more than 10 consecutive seconds as it consumes an excess of battery power. If the engine cannot be started within 10 seconds, wait for 30 seconds and try again.**

6. When the engine is started, release the key. Then, the key is automatically turned back to the "ON" position.
7. Warm up the engine for 3 to 4 minutes (10 minutes in winter) after the engine is started.



(1) Instrument pane

(2) Engine oil pressure warning lamp

(3) Charge Warning Lamp

8. Check to see that all the warning lamps on the instrument cluster are turned "OFF."

If any lamp remains on, immediately stop the engine and determine the cause.



CHECKING WARNING LAMPS

1. If the oil pressure warning lamp (2) does not go off in 4 to 5 seconds after the engine is properly started, stop the engine immediately and check the engine oil level. If the engine oil level is proper, contact your local **KIOTI Dealer**.

WARNING

- *The engine can be severely damaged if it is run with the oil pressure warning lamp ON.*

2. If the charge warning lamp (3) does not go off in 4 to 5 seconds after the engine is properly started, it means that the battery is not being charged. Have the charging system, such as the battery and alternator, inspected.
3. Refer to “Instrument panel” in chapter 4 for detailed information about other indicators and lamps.

WARNING

- *If driving the machine for an extended period of time with the charge warning lamp ON, the battery can be discharged and the machine’s electrical system can be damaged.*

STOPPING ENGINE

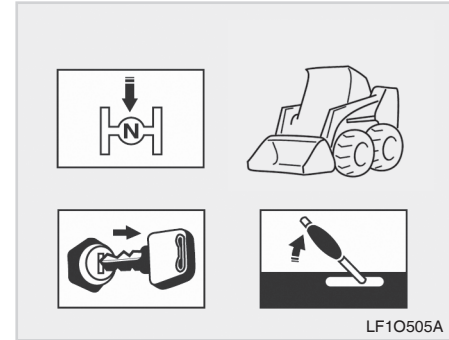

1. Make sure to reduce the engine rpm before stopping the engine.
2. Place the lift arm and the bucket safely on even ground.
3. Run the engine at the idle speed for approx. 2 to 3 minutes, and then turn the key switch to the “OFF” position to stop the engine.
4. Remove the key.

⚠ WARNING

- **Never touch the muffler or hot covers until they have cooled down after running the engine or driving the machine.**

⊕ IMPORTANT

- **Turn off all the electrical devices and remove the ignition key before leaving the machine.**

WARMING UP

The optimal temperature of the hydraulic oil is around 50 °C (122 °F). If the oil temperature is at 25 °C (77 °F) or below, drastic operation of the machine may cause severe damage to the hydraulic system, etc. Before starting the work, warm up the engine so that the hydraulic oil temperature reaches 25°C (77 °F) or higher.

HOW TO WARM UP

1. Start engine and high idle at 1,100 RPM's for 5 minutes.
2. Increase the engine to 1,500 RPM's and begin slowly moving the machine forward and backwards approximately 10 feet in each direction and raise/lower the lift arm 3 feet. Repeat this step 5 times or for 5 minutes (whichever is longer) before positioning the machine to begin work.

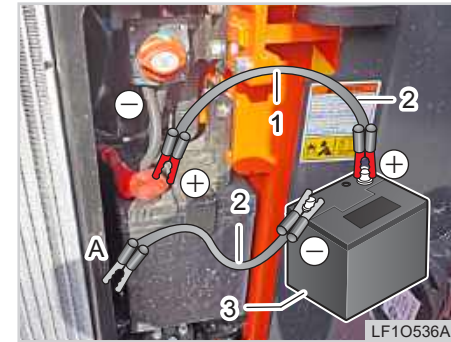
JUMP STARTING

- (1) Dead battery (2) Jump cable
(3) Helper Battery
(A) Ground (machine body)

If the battery is discharged and the engine cannot be started, it is possible to start the engine by connecting the discharged battery to a battery from another machine or other extra battery.

1. Check that the rated voltage of the discharged battery is same as the voltage of the other machine or vehicle for jump start. (Specification for this machine: 12 V)

2. Check the length of the jumper cable and position another machine near the machine with the discharged battery. Apply the parking brake, and stop the engine.
3. Wear protective glasses and gloves and open the rear door of both machines. Remove the battery terminal cover as necessary.
4. Connect the alligator clips on both ends of the red positive cable to the positive terminals of both batteries.
5. Connect one clip of the black negative cable to the negative terminal of the normal battery and the other clip to the machine body with the discharged battery. Make sure to connect the clip to the body part without paint.
6. Start the engine of the machine with the normal battery.
7. Start the engine of the machine with the discharged battery.
8. Disconnect the black cable from the negative battery terminals of the machine with the normal battery.
9. Disconnect the red cable.
10. Run the engine for at least 30 minutes to charge the discharged battery.
11. If the battery is discharged again, replace it or check the charging system, such as the alternator.

DRIVING AND OPERATION OPERATION BEFORE DRIVING



(1) Seat Adjustment Lever
(A) Pull

1. Adjust the seat so that the pedal and the steering wheel can be easily accessed.

WARNING

- **Check if the seat is securely locked after seat adjustment.**
- **Do not adjust the seat while driving. The seat may move suddenly causing loss of control of the machine.**



(1) Seat Belt

2. Wear the seat belt.

! WARNING

- ***The seat belt should go around your pelvis or as low as possible, not your waist or abdomen. Otherwise, the seat belt cannot protect you properly.***

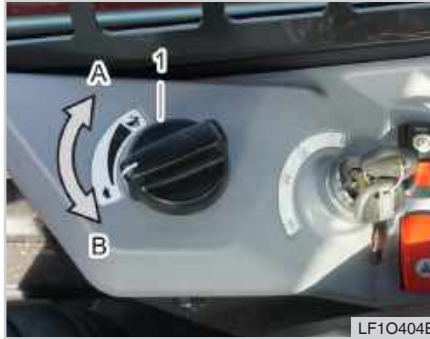

(1) Engine acceleration dial
(A) Acceleration (B) Deceleration

3. Increase the engine RPM slowly from idle speed to medium speed.



(1) Seat bar

4. Lower the seat bar.



(1) Hydraulic Unlock Safety Switch

5. Press the top of the hydraulic unlock safety switch to unlock the machine.



(1) Lift Arm (2) Bucket

6. Operate the lift arm and the bucket so as to raise the bucket about 20-30 cm from the ground.

FORWARD AND REVERSE DRIVING



(1) Driving lever
(A) Forward (B) Reverse

1. Push the left joystick control lever forward to move forward and pull it backward to reverse.
2. As the lever moves away from the neutral position, the driving speed increases.



TURNING



(1) Driving lever

(A) Left turn

(B) Right turn

1. To turn right, push the left control lever to the right side.
2. To turn left, push the left joystick control lever to the left side.

WARNING

To prevent accidents due to loss of steering control:

- *If you turn at high speed, the machine may turn over.*

DRIVING ON SLOPES

1. Please drive according to the conditions of the slope at safe speed so that the engine is not under heavy load if possible.
2. Make sure to shift to the lower gear in order to prevent the engine from stalling on an uphill.
3. Drive with the low speed gear on a downhill road to facilitate the engine brake.

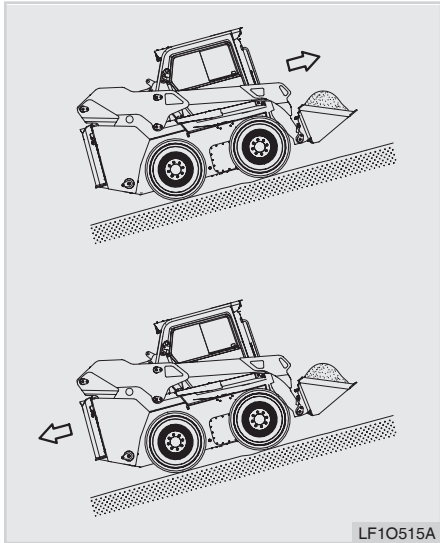

4. While driving with load, have the bucket positioned upward.

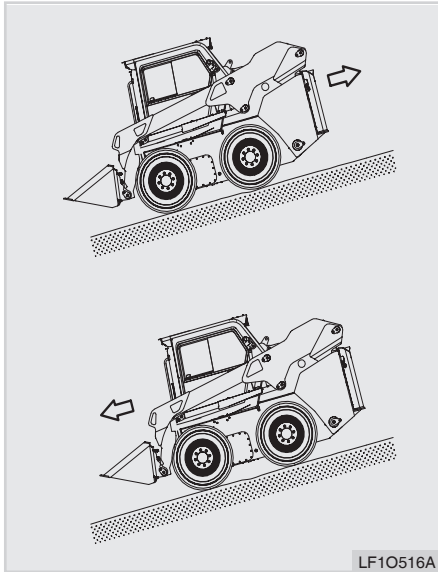

5. While driving without load, have the bucket positioned downward.

⚠ WARNING

- *The permitted limit for the operation of the engine is 20°, and therefore, under no circumstance should this angle be exceeded.*



PRECAUTIONS WHILE DRIVING ON THE ROAD



- (1) Turn signal lamp (LH)
- (2) Turn signal lamp (RH)

Driving on road should only be done under emergency situations and at a short distance. If it is inevitable, make the following cautions.

1. When you change the driving direction on a road, let other vehicles know your direction with the turn signal lights.
2. Check the tire inflation pressure and the driving speed limit before driving.
3. When driving for a long distance, make sure to stop the machine at every 12 km or every hour for 30 minutes to cool down the machine and check the fuel and coolant level.

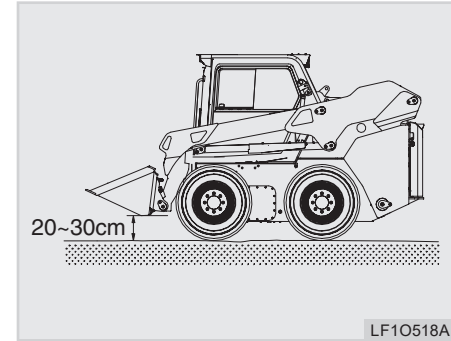

(A) 20 - 30 cm

4. Drive with the bucket empty and raised from the ground for 20-30 cm.

LOADING AND UNLOADING THE MACHINE TO/FROM A TRUCK

⚠ WARNING

- *When driving on a road, observe all local traffic and safety regulations. Only the operator should ride on the machine.*
- *If the machine is broken down during driving on a road, move it to a safe place with the flasher lights blinking. If not, it can cause a personal injury.*

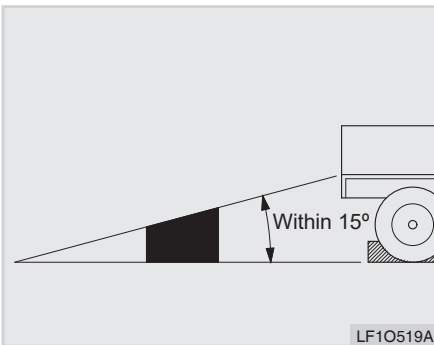

1. When loading the machine on a truck, apply the parking brake and chock the wheels so that the machine does not move. And, place the ramps between the trailer and the machine side by side.
2. For safe loading and unloading of machine, the ramps should have sufficient width, length, and be rated for the weight of the machine.
3. When loading the machine onto a truck, load it in reverse and lower the lift arm.
4. If the engine stops abruptly during loading the machine, move down to the road slowly and restart the engine and move up.



LIFTING THE MACHINE

⚠ WARNING

- Remove dirt on the tires so as to prevent slippage on slopes.
- Never change the direction of the machine on ramps under any circumstances.
- When transporting the machine with a truck, fix the machine firmly onto the truck and be aware of the height of the loaded machine to avoid hitting the ceiling of a tunnel or the bottom of a bridge. Make sure to follow this instruction as such accidents frequently happen.
- Adhere to any local, state, province or country regulations and/or laws related to hauling equipment.

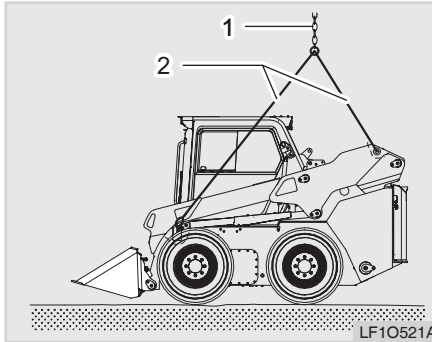

(1) Cable or Chain (2) Support bar

1. To lift the machine, check the weight, overall length, overall width, and overall height of the machine by referring to the specs table in Chapter 3.
2. The cable and support bar should be long enough so as not to have them touch the machine during towing. If necessary, cover the wire rope with cloth so as to prevent any damage of the machine.
3. Place the crane on an appropriate spot.

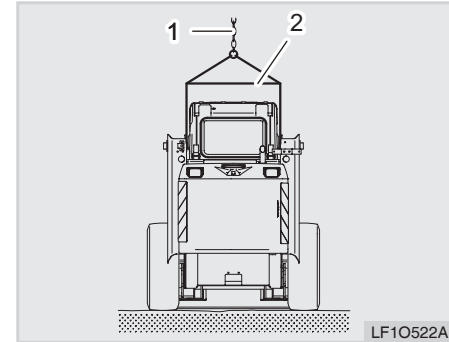

(1) Cable (2) Support bar

4. Use only the Cable or Chain and hoisting equipment that is not damaged, deteriorated, and is properly rated to handle the weight.
5. If the lifting method or the machine isn't properly secured, the machine may move during lifting, causing injuries or damage to the machine.
6. Do not apply abrupt load to the lifting cables or chains and tools.
7. Prevent access to the underneath or surrounding of the machine being lifted.

OPERATION

FILLING THE BUCKET

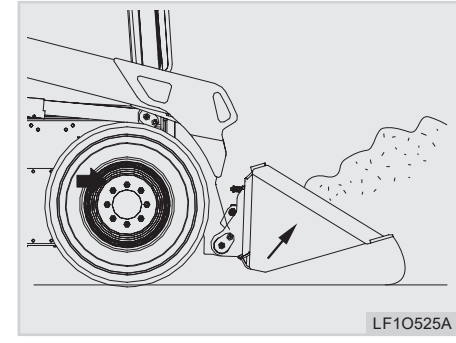
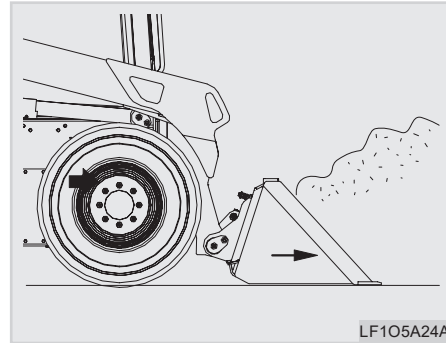
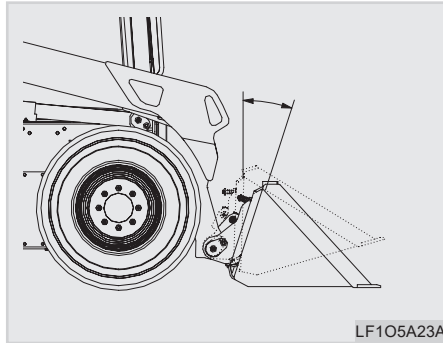

1. Place the bucket parallel to the ground surface, push the left joystick control lever forward to move the machine forward slowly and once the bucket is fully filled, curl the bucket back and slightly raise the lift arm to secure the load, then reverse the machine. The lift arm and bucket control levers at the same time to hold the objects in the bucket and reverse the machine.

2. When entering into the work site, place the bottom of the bucket parallel to the ground surface and make sure that no excessive load is applied to the machine body.

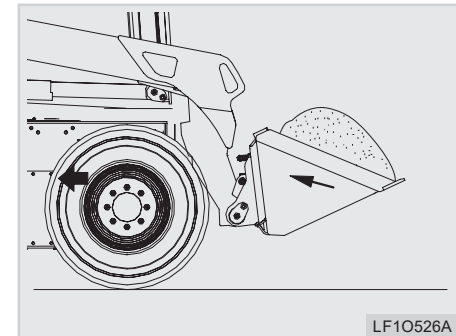

3. Never engage in a work that exceeds the specified load of the loader. Otherwise, it may lead to accidents.



DIGGING

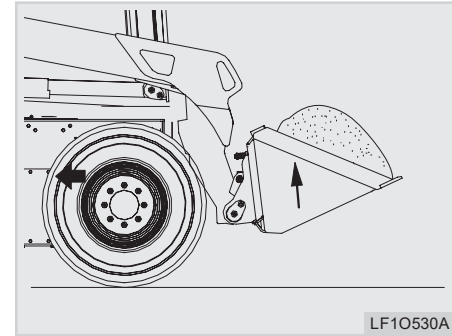
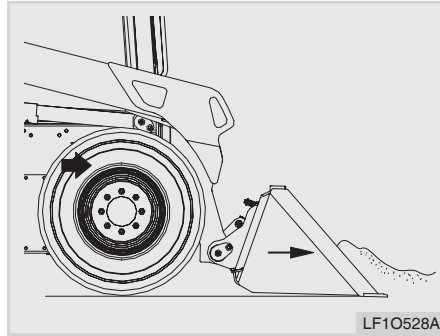
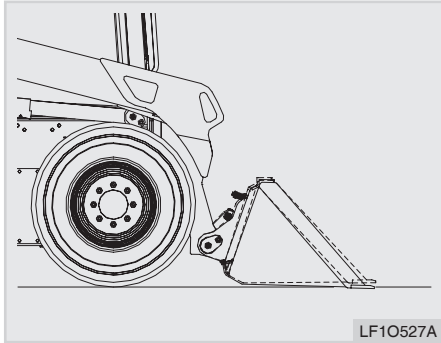

1. Maintain the angle so that the end of the bucket is placed to the ground surface, causing no excessive load.
2. Move the machine forward slowly, and once the bucket is fully filled, curl the bucket back while lifting the lift arm.

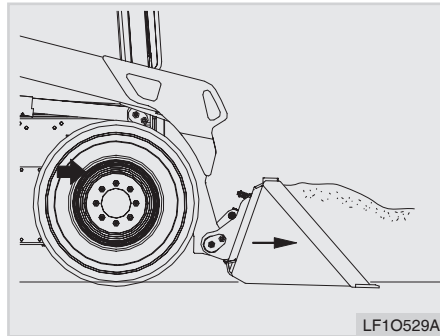

3. Do not apply an excessive angle between the bucket and the ground.

LEVELING

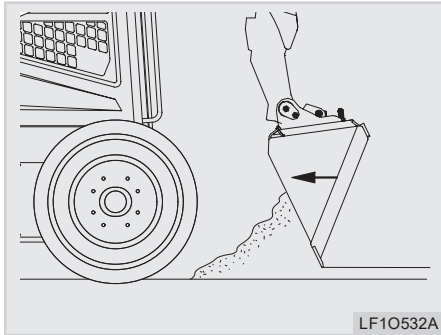
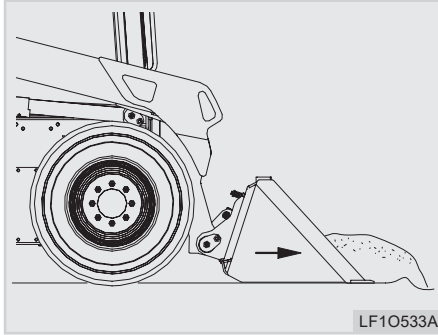
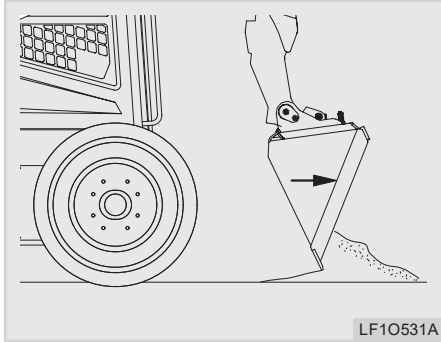

Move the bucket forward at a suitable angle against the ground surface, and move the machine forward or backward to level the ground surface.

FLOAT

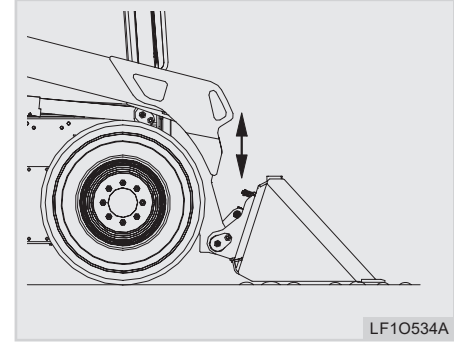

The float function allows for back-dragging and letting the bucket “float” while leveling the ground without applying down pressure.



DUMPING

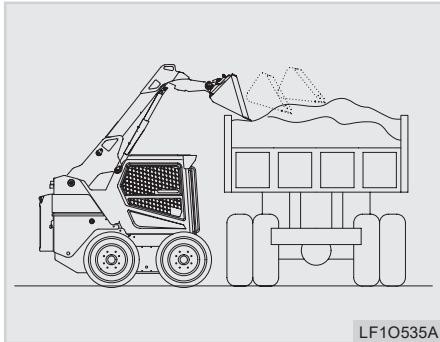

CAUTION

- When dumping into a truck or hopper, etc., make sure to pay attention to the bucket and the machine to avoid colliding or hitting anything unintentionally. Make sure not to have the bucket or the body of the machine collide with any objects.

1. When lifting the lift arm, adjust the angle of the bucket so as not to spill the content out. Once the lift arm is sufficiently raised, move the machine forward to pour the content.
2. The machine has a function to maintain the parallel state between the bucket and the ground surface automatically, depending on the lift arm's lifting angle. (The self-levelling system: optional)

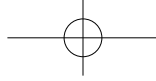

MEMO

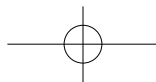



MAINTENANCE

MAINTENANCE CHECK LIST 6-2

- DAILY CHECK ITEM..... 6-2
- MAINTENANCE SCHEDULE CHART..... 6-3

LUBRICANTS 6-5

MAINTENANCE CODE..... 6-6

- OPENING THE REAR DOOR..... 6-6
- CHECKING AND ADDING FUEL..... 6-6
- CHECKING ENGINE OIL LEVEL 6-7
- CHANGING ENGINE OIL AND RE-PLACING FILTER..... 6-8
- CHECKING THE HYDRAULIC OIL LEVEL.. 6-10
- REPLACING THE HYDRAULIC OIL AND FILTER 6-11
- CHECKING AND REPLACING CHAIN CASE OIL..... 6-13
- CHECKING THE COOLANT LEVEL 6-13
- CLEANING THE RADIATOR..... 6-14
- CHECKING GAUGES, METERS AND INDICATORS 6-14
- CHECKING HEAD LIGHT, HAZARD LIGHT ETC..... 6-14
- CHECKING SEAT BELT AND CABIN..... 6-14

- GREASING INSTRUCTIONS 6-15
- CHECKING WHEEL BOLT/NUT TORQUE.. 6-16
- FUEL FILTER 6-16
- CLEANING AND REPLACING AIR CLEANER FILTER..... 6-17
- CHECKING FUEL LINE..... 6-19
- ADJUSTING FAN BELT TENSION 6-20
- BATTERY..... 6-20
- BATTERY SHUT OFF SWITCH..... 6-21
- CHECKING INTAKE AIR LINE..... 6-23
- CHECKING RADIATOR HOSE AND CLAMP 6-23
- FLUSHING COOLING SYSTEM AND CHANGING COOLANT 6-24
- ANTI-FREEZE 6-26
- BLEEDING FUEL SYSTEM 6-26
- CHECKING AND REPLACING WIPERS (CABIN MODEL ONLY)..... 6-28
- BODY FUSE 6-30
- SLOW BLOW FUSE 6-32
- REPLACE THE BULB..... 6-33
- REFRIGERANT INSPECTION 6-36

6

6



MAINTENANCE CHECK LIST

DAILY CHECK ITEM

Item	Service Schedule	Page
	Inspection description	
Engine oil level	Check the oil level and add as needed. Do not overfill.	6-8
Hydraulic (transmission/front axle) oil level	Check level and add as needed.	6-11
Air cleaner and its filter	Check the filter condition for leakage and damage. Clean the element.	6-18
Engine cooling system	Clean the radiator, screen and grill. Check coolant level and add anti-freeze if necessary.	6-14
Seat belt and seat bar	Check the seat belt and mounting hardware. and if necessary, repair or replace it. Check the seat bar operation.	6-15
Tires	Check for wear, damaged tires and ensure for proper sized tires and correct air pressure.	-
Parking brake	Check operation and adjust if required.	-
Cleaning pedals	Clean accelerator pedal, and footrest area.	-
General information	Check for loose or broken parts, damaged cabin components, instrument panel operation, loose wheel nuts / bolts, oil leaks and damaged or missing signs (decals). Replace them as necessary.	-
Bucket and lift arm	Check mounting hardware for loose or broken parts.	-
Battery	Check the voltage and check for discharge.	6-21
Cabin (if installed)	Check each device for proper operation and cleanliness	6-15

※ Refer to section "Maintenance code" for detailed information related to maintenance codes.



MAINTENANCE SCHEDULE CHART

No.	Inspection item	Schedule	Run hour										Run age		As necessary	Remarks	Page	
			10	50	100	200	250	400	500	800	1000	2000	1 year	2 years				
1	Hydraulic oil	Check and Replenish	○															6-11
		Replace									○							6-12
2	Battery (voltage)	Check			○													6-21
3	Hydraulic oil filter	Replace and adjust					●		○									6-12
4	Safety bar - check for any malfunctioning	Check	○															-
5	Air cleaner element	Check and clean					○											6-18
		Replace													○			6-24
6	Radiator coolant	Check and Replenish	○															6-13
		Replace										○		○		at coming first		6-25
7	Engine oil	Check			○													6-8
		Replace					○											6-9
8	Engine oil filter	Replace				○												6-9
9	Pins - grease	Check and Replenish	○															6-16
10	Fuel filter element	Replace				○												6-17
11	Fan belt tension and damage	Check				○												6-20
12	Fuel-Water Separator	Check				○												6-17



No.	Inspection item	Schedule	Run hour										Run age		As necessary	Remarks	Page	
			10	50	100	200	250	400	500	800	1000	2000	1 year	2 years				
13	Fuel hose	Check			○													
		Replace												○				
14	Tire wheel nut - torque	Check	○															6-17
15	Tire (inflation pressure)	Check and Replenish	○															-
16	Chain case oil	Check	⊙															6-13
		Replace									○							6-13
17	HST filter	Replace					⊙		○									-
18	Engine valve clearance	Adjust								○								-
19	Chain tension	Replace and adjust									○					○		-

⊕ IMPORTANT

- ⊙ must be done after the first 10 hours or 250 hours of operation.
- The service interval is based on the hour meter on the instrument panel.
- This service interval assumes general maintenance condition and may not be suitable for other conditions, depending on the work site's conditions.
- Make sure to stop the engine before replenishing oil or fluid.
- If the oil temperature is high, it may flow out and therefore, do not loosen the cap or the drain plug.
- Loosen the cap slowly so that the internal pressure can be slowly released.
- The surface of the instrument panel and the control panel should be always kept clean, and any damaged or defect parts should be replaced with new ones.



LUBRICANTS

To prevent serious damage to the equipment, use only genuine **KIOTI** fluids, oils and greases or equivalents.

No.	Item	Capacity [us gal (ℓ)]	Oil
1	Fuel	26.4 (100)	Ultra low sulfur diesel (sulfur content: 15ppm or less)
2	Operating oil	10.0 (38)	Hydraulic oil ISO VG 46
3	Radiator coolant	2.75 (10.4)	Anti-freezing solution: Ethylene glycol + Pure water (50:50)
4	Engine oil	2.4 (9)	Spec: API CJ-4 or higher Viscosity (SAE): SAE 15W40
5	Pins - grease	Sufficient amount	Grease oil NLGI #2
6	Chain case oil	3.4 (13)	SAE 10W-30 or equivalent

WARNING

- **Check the oil level periodically. Correct the oil level, if needed, before operating.**
- **Always check and add oil with the machine on a flat, level surface.**

MAINTENANCE CODE OPENING THE REAR DOOR

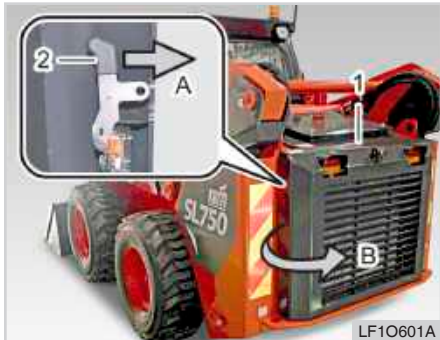

- (1) Rear door
(A) Pull
- (2) Opening knob
(B) Open

1. It is very easy to open the rear door with one touch pulling knob.
2. The hood stays open by itself with an air cylinder. To close it, just press down.



- (1) Rear door



CAUTION

- **Never open the rear door while the engine is running.**

CHECKING AND ADDING FUEL



- (1) Fuel Tank Cap

The fuel tank is installed in the middle of the machine body. Make sure to use pure and high-quality diesel fuel.

Fuel Tank Capacity [us gal (ℓ)]

26.4 (100)



1. Turn the key switch to "ON" and check the amount of fuel with the fuel gauge.
2. If the indicator on the fuel gauge is close to "E" or the fuel level is low, open the fuel tank filler cap and add the fuel.
3. After adding the fuel, close the fuel tank filler cap.

**CAUTION**

To avoid personal injury:

- Do not smoke while refueling.
- Add fuel in a well-ventilated area.
- Be sure to stop the engine before refueling.
- As dirt or sand contained in fuel may cause malfunction to the fuel injection pump, use the strainer when refueling.

**IMPORTANT**

- Be careful not to let the fuel tank become empty. Otherwise air will enter the fuel system, necessitating bleeding before next engine start.
- Be careful not to spill during refueling. If a spill occurs, wipe it off at once, to avoid any potential risk of fire.
- When operating the machine in cold temperatures, switch to a winter blend fuel for optimal performance.

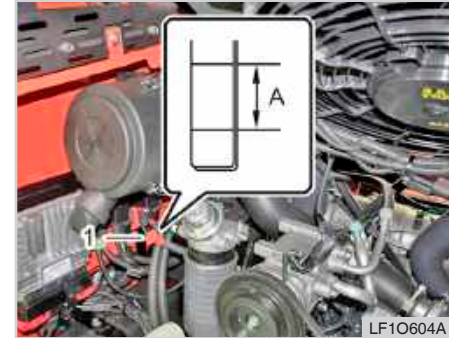
CHECKING ENGINE OIL LEVEL

- (1) Oil filler neck (2) Oil dipstick
(A) Oil Level is Acceptable Within This Range

1. Check the engine oil daily.
2. Park the machine on a level ground and lower the attachment.
3. If the engine was just running, wait for approx. 5 minutes before checking the oil level.

**CAUTION**

To avoid injury:

- Be sure to stop the engine before checking the oil level.

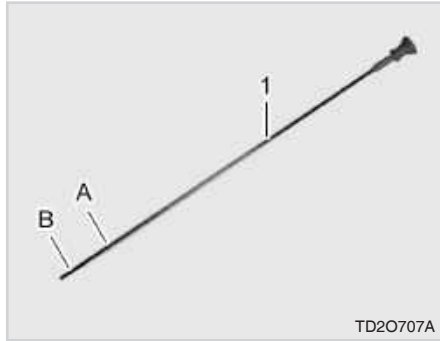

TD2O707A

(1) Oil dipstick
(A) Upper limit

(B) Lower limit

4. Pull out the oil dipstick, clean it, and then insert it into its original position. Then, pull it out again and check if the oil level is within the specified range.
5. If the oil level is too low, add some oil so that the level is within the allowable range.

⊕ IMPORTANT

- When using oil of different maker or viscosity from the previous one, remove all of the old oil. Never mix two different types of oil.
- Do not start the engine when the oil level is below the lower limit.
- Wipe the oil dipstick with clean cloth or tissue. If foreign material enters the oil sump, it can lead to malfunction of the engine.
- Never add oil over the upper limit.

CHANGING ENGINE OIL AND REPLACING FILTER

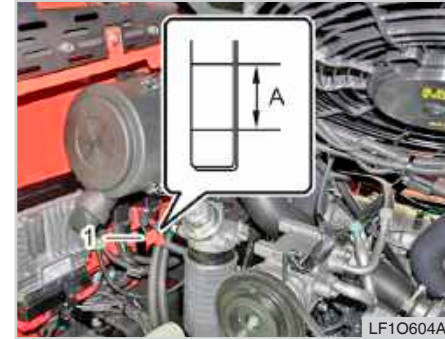

LF1O604A

(1) Oil filler hole (2) Oil dipstick
(A) Oil level is acceptable within this range

1. Park the machine on a level ground and start the engine to warm it up.
2. Stop the engine, set the parking switch to the parking state ((P)).
3. Wait until the oil is cooled down.

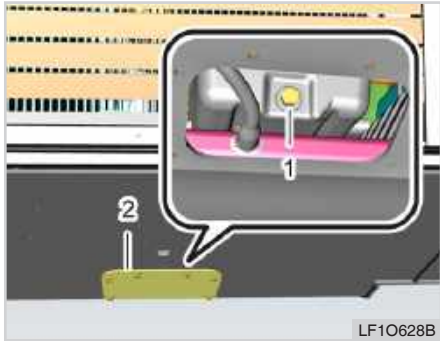

(1) Drain Plug (2) Maintenance cover

4. To drain the oil used, first install the oil pan at the bottom of the engine, remove the maintenance cover, and turn the drain plug counterclockwise to drain the oil completely.



(1) Engine Oil Filter

5. Remove the engine oil filter on the right side of the engine.
6. Apply a thin film of oil to the O-ring of a new filter and tighten the new filter firmly by hand.
7. Fill the engine oil to the specified level and tighten the oil filter to the specified torque.

Oil Capacity [us gal (ℓ)]
2.4 (9)

8. Run the start motor for approx. 10 seconds to distribute oil to each part of the engine.
9. Run the engine for approx. 5 minutes and check for proper operation through the engine oil warning lamp. Then, stop the engine. (It is normal that the oil warning lamp is off while the engine running)
10. Check the engine oil level again with the oil dipstick. If the level is low, add more oil.

NOTE

- The engine oil filter should be replaced when changing the engine oil.

⚠ WARNING

- *The engine oil is very hot while the engine is running or right after the engine is stopped. Be careful to avoid burns.*
- *Avoid oil contact while changing or adding engine oil and wear eye protection to prevent eye contact.*
- *Avoid prolonged exposure or contact with fluids. If swallowed, contact a doctor or poison control center immediately.*
- *Dispose used fluids through recycling or other approved methods in your local area.*

⊕ IMPORTANT

- **Use only specified engine oil and KIOTI genuine filter to insure smooth operation and durability of the engine.**

⚠ CAUTION

To avoid injury:

- **Be sure to stop the engine before changing the fluid or replacing the filter.**
- **Check the engine oil level before every operation of the machine. If the engine oil is insufficient, the engine can be damaged, and this is not covered by warranty. Be sure to add the engine oil when its level is below the lower limit of the oil dipstick.**
- **Do not dispose of used oil and oil filter into drainage and other places not designated by regulations. Observe applicable regulations when disposing used oil and filters.**

CHECKING THE HYDRAULIC OIL LEVEL

- (1) Hydraulic oil level sight glass
 (A) Optimal level (it should be up to the center of the gauge.)

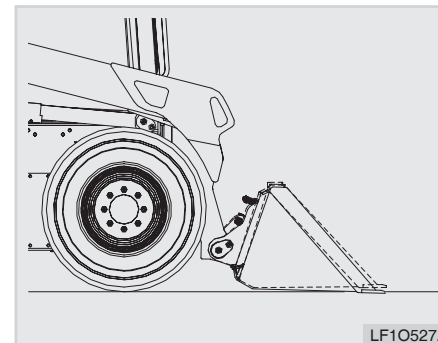



(1) Hydraulic oil filler neck

1. Park the machine on a level ground and lower the bucket onto the ground.
2. Stop the engine and wait for some five minutes.
3. The hydraulic oil level should be up to the center of the gauge. (The gauge is located at the lower right of the seat inside the cabin.)
4. If the oil level is too low, add some oil so that the level is within the allowable range.

⊕ IMPORTANT

- If the level is low, do not run the engine.
- Never add oil over the upper limit.
- Be sure to check the oil level after installing a hydraulic attachment. Add fluid as needed.
- Check the oil level with the cylinders of an attachment extended and check again with the cylinders retracted. Add oil to adjust the oil level within the range of the oil limit. (Upper or lower)

REPLACING THE HYDRAULIC OIL AND FILTER



(1) Return filter

If hydraulic oil is contaminated or a repair is required, it should be replaced. Make sure to replace the hydraulic oil filter element as well.

However, replace the hydraulic oil filter element only at every 1,000 hours of operation.

1. Park the machine on a level ground and start the engine to warm it up.
2. Stop the engine, and remove the drain plug.

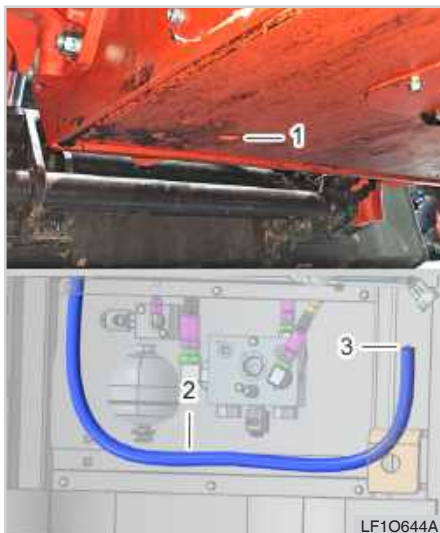

(1) Drain hole (2) Drain hose
(3) Plug

3. To drain used oil, point the drain hose below the step toward the hole on the floor in the front wheel (left), and loosen the plug to drain the oil completely.

5. Apply a thin film of clean oil onto the O-ring of a new filter.
6. Tighten the filter until it touches the mounting surface. Then, tighten the filter for a half turn further with a hand.
7. After installing a new filter, run the engine for a few minutes and stop it.
8. Check the oil level again and add more oil to the specified level.

Oil Capacity [us gal (ℓ)]

10.0 (38)



CAUTION

To avoid injury:

- **Be sure to stop the engine before changing the fluid or replacing the filter.**
- **Cool down the fluid sufficiently, to avoid the possibility of burns from hot fluid.**

⊕ IMPORTANT

- **Use genuine KIOTI parts for optimum performance and uptime.**
- **Do not operate the machine immediately after changing transmission fluid. Run the engine at medium speed for a few minutes to prevent damage to the hydraulic system.**



CHECKING AND REPLACING CHAIN CASE OIL



(1) Sight glass & filler hole (2) Drain plug

Replace the oil according to the driving chain maintenance interval or chain case oil replacement interval.

1. Park the machine on a level ground and stop the engine.
2. Open the drain plug and drain the oil completely.
3. Check the oil level again and refill oil to the specified level.

Oil Capacity [us gal (ℓ)]

3.4 (13)

CHECKING THE COOLANT LEVEL



(1) Reservoir Tank
(A) FULL (B) LOW

1. Check to see that the coolant level is between the "FULL" and "LOW" marks of the reservoir tank.
2. When the coolant level drops due to evaporation, add water only up to the "FULL" level mark. In case of leakage, add anti-freeze and water in the specified mixing ratio up to the "FULL" level mark. (Refer to the instructions for cleaning the cooling system and changing coolant in Chapter Maintenance for every two years.)

3. The machine is furnished in the factory with a mixture of anti-freeze (ethylene glycol) and water in a ratio of 50:50 which is usable in any season.

CLEANING THE RADIATOR



(1) Radiator

(2) Rear cover

1. Check for foreign materials on the radiator and the rear cover.
2. Remove any foreign materials.

CAUTION

To avoid accidents:

- **Be sure to stop the engine before cleaning.**

IMPORTANT

- **The radiator and the rear cover must be clean from debris to prevent the engine from overheating and to allow good air intake for the air cleaner.**

CHECKING GAUGES, METERS AND INDICATORS

1. Inspect the instrument panel for broken gauge(s), meter(s) and indicators.
2. Replace if broken.

CHECKING HEAD LIGHT, HAZARD LIGHT ETC.

1. Inspect the lights for broken bulbs and lenses.
2. Replace if broken.

CHECKING SEAT BELT AND CABIN

1. Always check the condition of the seat belt and cabin before operating the machine.
2. Replace if damaged.



GREASING INSTRUCTIONS

Apply quality multi-purpose grease to the locations specified in the following figure at every 10 hours of use or when necessary. Also, record the operating hour on every application.



(1) Upper part of the bucket tilt cylinder



(1) Upper part of the opening of the engine compartment



(1) Lift arm cylinder
(2) Hinge pin area



(1) Hinge pin area



(1) Lower part of the opening of the engine compartment



(1) upper/lower parts of the lift arm cylinder

CHECKING WHEEL BOLT/NUT TORQUE



(1) Front wheel

(2) Rear wheel

Check the wheel bolts and nuts regularly especially when new. If they are loose, tighten them as follows.

Item		Tightening torque
Front wheel	Nut	196~225 N·m 144~166 lbf·ft
Rear wheel	Nut	20 ~ 23 kgf·m

⚠ CAUTION

To avoid injury:

- Never operate the machine with a loose rim, wheel, or axle.
- Any time bolts and nuts are loosened, retighten to specified torque.
- Check all bolts and nuts frequently and keep them tight.

FUEL FILTER

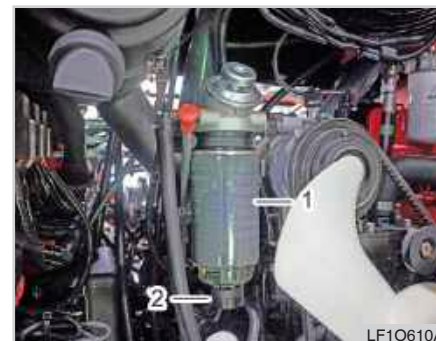

(1) Fuel filter

(2) Drain plug

REMOVING WATER FROM FUEL FILTER

1. Water and dust in fuel are accumulated in the filter. Remove the plug from the bottom of the fuel filter to drain water.
2. After draining, tighten the plug by hand. (Do not use a tool.)
3. Start the engine and check for fuel leakage.



REPLACING FUEL FILTER

1. Wipe the surface of the fuel filter clean.
2. Unscrew the plug on the bottom of the fuel filter to drain fuel.
3. Separate the fuel filter.
4. Remove foreign materials, such as dirt, thoroughly, and replace the fuel filter with a new one.

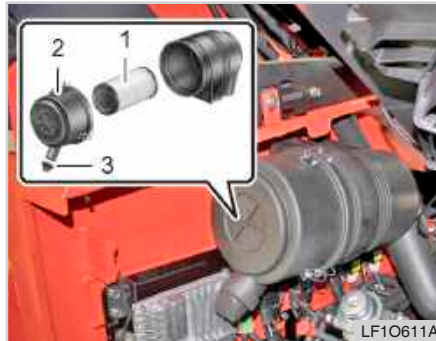

(1) Filter

(2) Dust cap

(3) Evacuator valve

If the air cleaner is not in a good condition, the lifetime of the engine can be shortened, excessive soot can be produced, and the engine power can be deteriorated. Therefore, the filter should be inspected frequently. Its replacement interval can be changed according to driving conditions. Replace the filter according to the following procedure:

1. Open the rear door and check the suction hose and air cleaner hous-

ing for damage.

2. Unscrew the air cleaner clip and remove the cover.
3. Clean the inside of the air cleaner housing thoroughly.
4. Replace the filter and check the housing for damage.
5. Install the cover and fix it with the clip.

IMPORTANT

- **The air cleaner will only fulfill its function if it is correctly and regularly maintained. A poorly maintained air cleaner will mean loss of power, excessive fuel consumption and a reduction in engine life.**
- **Do not run the engine with filter element removed.**

 **CAUTION**

- **Use only a KIOTI genuine filter. If using a product other than the genuine one, it can damage the engine internal section and sensor.**
- **Make sure that no dust enters the system by installing the cover firmly.**
- **When removing the filter, be careful not to let foreign material enter the air inlet.**

 **NOTE**

- The air cleaner uses a dry element. Never apply oil.
- Make sure that dust is not accumulated over the half of the dust cap. Remove the dust cap, wipe out any dust and clean the filter every week. If the machine is operated in extremely dusty conditions, daily inspection is required.
- Do not service the filter unless it should be cleaned.
- For filter replacement, refer to the instruction for replacing the air cleaner filter for every year.
- When installing the cover, make sure that the dust collection valve is heading down.

 **IMPORTANT**

- **Be sure to refit the cover with the arrow ↑ (on the rear of cover) upright. If the cover is improperly fitted, the evacuator valve will not function and dust will adhere to the element. (Refer to the instructions for replacing the air cleaner filter for every year in Chapter Maintenance.)**

EVACUATOR VALVE

Open the evacuator valve gap by hand once a week under ordinary conditions or daily when used in dusty conditions to get rid of large particles of dust and dirt.



CHECKING FUEL LINE



LF1O612A

(1) Fuel line

(2) Fuel hose clamp

It is recommended to check the fuel line connections every 100 hours, and should be replaced every 2 years unless the operation exceeds 1,000 hours in 2 years.

1. If the hose clamps are loose, apply a slight coat of lubricant onto the threads and securely tighten it.
2. The fuel line is made of rubber and ages regardless of period of service. Change the fuel pipe together with

the hose clamps every two years and securely tighten.

3. If the fuel lines and hose clamps are found damaged or deteriorated earlier than two years, then change them immediately.
4. After the fuel line and hose clamps have been changed, bleed the fuel system.

WARNING

- **Stop the engine when checking the items above.**
- **Inspect the fuel line regularly. The fuel lines are subject to wear and aging. Failure to perform periodic inspections may lead to a fuel leak. Fuel leaking on a hot engine could cause a fire.**

IMPORTANT

- **When disconnecting the fuel line for replacement, plug both ends with cloth or paper to prevent dust or foreign material from entering it. Otherwise, the fuel injection pump can be damaged. Pay extra caution to the fuel pump to prevent dust from entering it.**

ADJUSTING FAN BELT TENSION

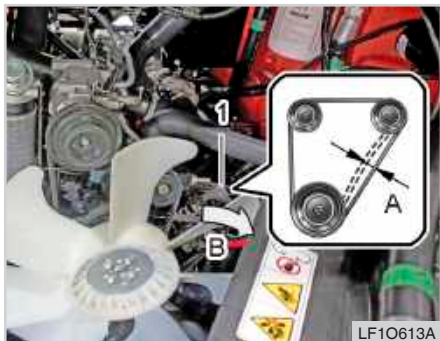

(1) Adjusting Bolt
(A) Adjusting Belt Tension
(B) Pull

In order to extend the fan belt's life-time, the tension of the belt should be correctly adjusted if it or loosens. The belt tension should be inspected regularly according to the following procedure:

1. Stop the engine and check the parking status on the instrument panel.
2. Open the rear door.
3. In order to measure the belt tension, apply thumb pressure strongly to the "A" location of belt.

Belt deflection for proper fan belt tension (A)

A deflection of between 0.28 ~ 0.35 in. (7 ~ 9 mm) when the belt is pressed in the middle of the span.

4. If the tension is incorrect, loosen the alternator mounting bolts and, using a lever placed between the alternator and engine block, pull the alternator out until the deflection of the belt falls within acceptable limits.
5. Be sure to retighten the alternator mounting bolt and hinge bolt securely after adjusting belt tension.
6. Replace the fan belt if it is damaged, cracked or worn.

CAUTION

To avoid injury:

- Be sure to stop the engine before checking belt tension.

BATTERY

PRECAUTIONS FOR HANDLING



(1) Battery

Mishandling the battery shortens the service life and adds to maintenance costs. If the battery is insufficiently charged, the headlights may dim and the engine is hard to start. It is important to inspect the battery periodically.

1. The battery cable should always be clean and firmly connected. When installing a battery, clean its terminals.



2. Check the battery and cable for damage and corrosion.
3. Apply grease to the terminals and cable end in order to prevent corrosion.

WARNING

- **The battery gas can explode. Do not expose the battery to flames or sparks. It may cause a fire.**
- **The battery fluid contains sulfuric acid that can burn you. Do not allow the battery fluid to contact your eyes, skin, or painted surfaces. If you accidentally get it in your eyes or on your skin, flush with water and contact your doctor.**
- **Be sure to wear eye protection while working on the battery. The battery fluid can hurt your eyes.**
- **Use only the battery with the specified voltage. Otherwise, it may cause a fire.**

BATTERY SHUT OFF SWITCH

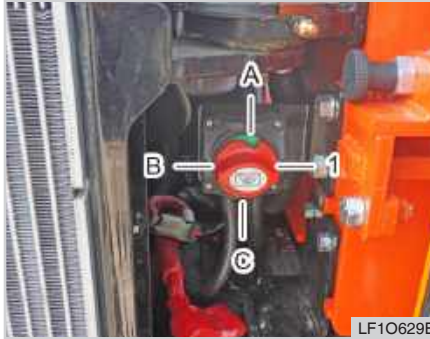

- (1) Battery shut off switch
(A) Power ON (ON)
(B) Power shut off (OFF)
(C) Removing the handle

Setting the battery switch OFF shuts off the power while setting it ON supplies the power. For long-term storage, set the switch OFF.

For long-term storage, turn the handle to the removal position to remove it and place it in a safe place.



CAUTION

- **Stop the engine and wait for about two minutes, and then turn the battery switch to “OFF” or disconnect the battery terminal.**
- **After the engine is stopped, the ECU self-check takes about 2 minutes. If the battery is removed before this 2 minutes, ECU errors would occur.**

CHARGING

1. To slow charge the battery, connect the battery positive terminal to the charger positive terminal and the negative to the negative, and then recharge in the standard fashion.
2. Boost charging is only for emergencies. It will partially charge the battery at a high rate and in a short time. This procedure will shorten the battery's service life.
3. When the battery is discharged and should be replaced, replace it with a new one with same specification and capacity.

Battery type	Volts (V)
110AH	12



CAUTION

- **The charge warning lamp comes on if the charging system is defective. If it comes on while driving, have the system checked or repaired by your local KIOTI dealer.**
- **Keep the battery fully charged. If the battery fluid concentration is too low during the winter season, the battery may freeze.**
- **Do not start the engine when the battery is frozen. Try to warm it up first.**
- **If the battery is not securely installed, the battery case and electrolytes could be damaged by vibration. To prevent the battery acid from contacting the terminals, apply grease around the battery terminals and connections.**
- **Never check the charge status of the battery by placing a metal object across the posts. Use a voltmeter or hydrometer.**

DIRECTION FOR STORAGE

1. When storing the machine for a long period, remove the battery from the machine and store in a dry place out of direct sunlight.
2. The battery self discharges while it is stored. Recharge it once every three months in hot seasons and once every six months in cold seasons.



CHECKING INTAKE AIR LINE



(1) Air line hose

(2) Clamp

1. If the hose clamps are loose, tighten clamps securely.
2. If the hoses and clamps are damaged, you must replace them at once. Failure to do so could lead to engine damage.

CHECKING RADIATOR HOSE AND CLAMP



(1) Clamp

(2) Radiator hose

Check to ensure the radiator hoses are free from damage and are tightened properly every 200 hours or every 6 months, whichever comes first.

1. If the hose clamps are loose or water leaks from hose, tighten clamps securely.
2. If the radiator hose is swollen, hardened, cracked or damaged, it should be replaced immediately. Also, it should be replaced every 2 years.

Take the following actions in the event the coolant temperature reaches the boiling point, what is called "Over-heating".

1. Stop the machine in a safe place and keep the engine unloaded idling.
2. After 5 minutes of unloaded idling, shut the engine down.
3. Keep yourself away from the machine for another 10 minutes or until steam has stopped blowing out of the engine.
4. Make sure that there is no danger and repair the cause of the over-heating according to the manual's instruction. (Refer to the instruction in Chapter. Troubleshooting before starting the engine.)

FLUSHING COOLING SYSTEM AND CHANGING COOLANT



(1) Drain plug

1. Park the machine on level ground, stop the engine and let the engine cool down.
2. To drain coolant, remove the drain plug from the radiator and turn the radiator cap to the 1st notch to release pressure in the radiator. Then, remove the cap completely.
3. After all coolant is drained, fit the drain plug.

4. Use clean, fresh water and anti-freeze to fill the reservoir tank.
5. Follow the cleaner manufacturer's instruction.

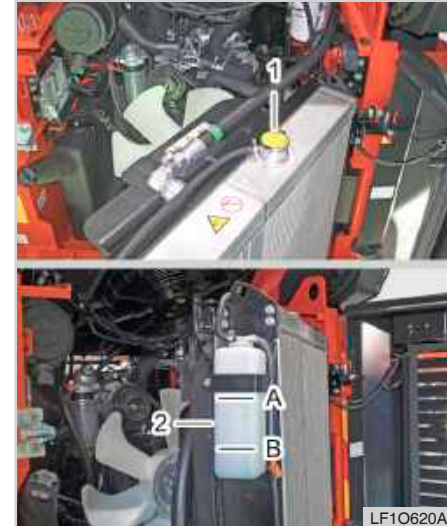

(1) Radiator cap
(A) FULL

(2) Reservoir tank
(B) LOW

6. Install the radiator cap securely.
7. Start and idle the engine for few minutes.
8. Stop the engine and let it cool.



9. Drain water and cooling system cleaner and close drain cock. Then, fill with antifreeze and water mixture and close radiator cap securely.
10. Idle the machine until it reaches the operating temperature.
11. Check the coolant level in the reservoir tank. If the level is low, add coolant.

Coolant capacity
[us gal (ℓ)]

2.75 (10.4)

**CAUTION**

To avoid accidents:

- **Do not remove the radiator cap while the coolant is hot. Steam or scalding liquids released from hot cooling system can cause serious burns. Cool down the engine first.**
- **Even though the coolant is cooled down, turn the cap to its first stop and then wait until it is depressurized before removing the cap completely.**

**IMPORTANT**

- **Do not start engine without coolant.**
- **Use clean, fresh water and anti-freeze to fill the radiator and reservoir tank.**
- **When the anti-freeze is mixed with water, the anti-freeze mixing ratio must be no less than 50% mixture of water and anti-freeze.**
- **Securely tighten radiator cap. If the cap is loose or improperly fitted, water may leak out and the engine could overheat.**
- **If the radiator cap has to be removed, follow the caution above and securely retighten the cap.**
- **Use clean, fresh water and anti-freeze to fill the reservoir tank.**
- **If the coolant leaks, contact your local KIOTI Dealer.**

ANTI-FREEZE

This machine is filled with 50% of ethylene glycol at factory.

If the anti-freeze has been replaced by tap water later on, the coolant can freeze, leading to damage to the cylinder and radiator when the ambient temperature is below zero (32 °F).

Therefore, make sure to change water into anti-freeze before winter season comes.

When changing the anti-freeze with one of another type, flush the cooling system several times and contact a professional for the mixture ratio.

Anti-freeze % (Ethylene glycol)	Freezing Point		Boiling Point	
	°F	°C	°F	°C
40	-12	-24	222	106
50	-34	-37	226	108

* At 760 mmHg pressure (atmospheric). A higher boiling point is obtained by using a radiator pressure cap.

NOTE

- The temperatures shown on the left are industry standards that necessitate a minimum glycol content in the concentrated antifreeze.
- When the coolant level drops due to evaporation, add water only. In case of leakage, add anti-freeze and water in the specified mixing ratio.
- Anti-freeze absorbs moisture. Keep unused anti-freeze in a tightly sealed container.
- Do not use radiator cleaning agents when anti-freeze has been added to the cooling water. (Anti-freeze contains an anti-corrosive agent, which will react with the radiator cleaning agent forming sludge which will affect the engine parts)

BLEEDING FUEL SYSTEM



(1) Drive pump

(2) Air bleeding bolt

1. Make sure that the amount of fuel in the fuel tank is sufficient.
2. If air is introduced into the fuel filter, unscrew the air bleeding bolt shown in the above figure, and turn the key switch to run the drive motor. Then, air in the fuel filter is bled through the bleeding bolt as shown in the figure above.

 **NOTE**

- Bleeding is not necessary if installing the fuel port after fueling.

3. When fuel is visible through the bleeding bolt, tighten the bolt and start the engine.

IMPORTANT

To protect the catalyst filter, keep the followings:

- Make sure to use only genuine fuel.
- Keep the engine oil replacement schedule.
- Check the engine oil level frequently to keep it to the specified level.
- Avoid any unnecessary engine idling.
- Never stop the engine during driving.
- Do not use any engine oil additive or fuel additive.
- Avoid driving with any warning lamp illuminated.
- Do not allow any flammable materials, such as dry grass and paper, to come near the catalyst filter while parked.

CAUTION

- Never bleed the fuel system while the engine is hot.

IMPORTANT

- After bleeding, fuel without air bubbles is filtered by the fuel filter and is transferred to the fuel injection pump. Maintain the proper fuel level in the fuel tank before the fuel tank becomes empty. If all fuel is completely consumed in a Diesel engine, fuel should be added to the fuel tank and then the fuel system should be bled.

NOTE

- If the engine cannot be started even after bleeding the fuel system, contact your local Dealer.

CHECKING AND REPLACING WIPERS (CABIN MODEL ONLY)

CHECKING



(1) Wiper

Check the operation and wear condition of wiper blades regularly.

CHANGING

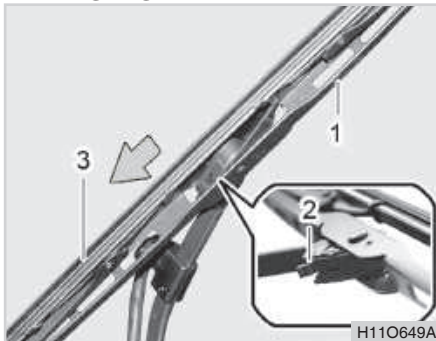

(1) Wiper arm (2) Wiper mounting lever
(3) Wiper blade

1. Stand the wiper arm and prepare it so as to replace the wiper blade.
2. Hold the blade with one hand. Press the blade mounting lever with the other hand and separate the blade from the mounting device.



(1) Wiper blade

3. Push the blade down and take it out in the direction of the arrow as if drawing a U-shape.

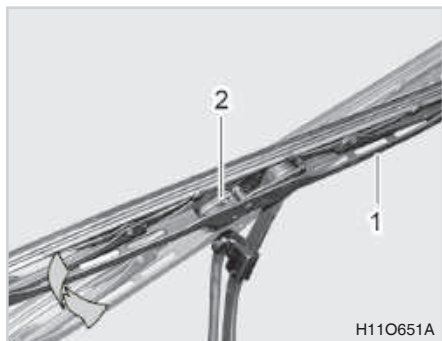

(1) Wiper arm (2) Mounting lever

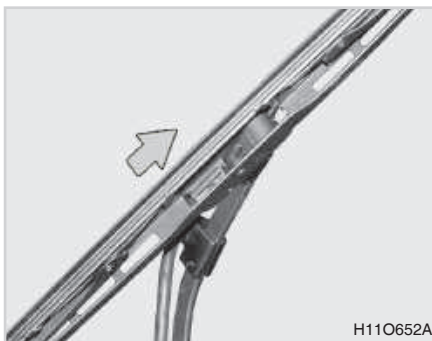

4. Place the new wiper blade in parallel, point the mounting lever downward, and put the wiper arm down to the mounting lever groove.

 **CAUTION**

- With the wiper blade removed, make sure not to have the wiper arm touch the window. It may damage window glass.

5. Push the wiper blade all the way up and install it so that the mounting lever is engaged with the wiper arm (make sure that you hear a click.)

 **CAUTION**

- When cleaning the windshield, stand the wiper blade, spray water using a hose, etc., and wipe it with clean cloth.

 **CAUTION**

- Do not continue operating the wipers when the wiper blade is frozen in winter or there is no washer fluid.
- To prevent the damage of the wiper blades, do not use synthetic detergent, thinner or other solvents on the windshield.

BODY FUSE



(1) Body fuse box (2) Body relay box

Fuses protect the machine's electrical system from potential damage.

A blown fuse indicates that there is an overload or short somewhere in the electrical system.

The fuse panel is located in the right section of the engine compartment.

RMS Alternator 10A	14Pin C/D/E/F/G/H 30A	Back Buzzer 10A
14Pin 10A	Light FR/RR 20A	Pilot Lock Bucket/Travel 20A
Electric Fan 25A	MCU/Cluster 15A	Parking 10A
Fuel Heater 25A	Power Socket 10A	Seat 15A
ECU_Key_Power 10A	Beacon Lamp 10A	Fan Clutch 5A
Room Lamp 10A	Aircon 30A	Spare 5A
Flasher Unit 10A	Stop Lamp 10A	Spare 10A
Left Joystick 10A	Right Joystick 10A	Spare 10A
Horn 10A	Cabin 10A	Spare 15A
ECU Sensor 10A	Valve Power 30A	Spare 20A
ECU Power 25A	Bluetooth Player 10A	Spare 25A
ECU Relay 5A	Wiper Washer 15A	Spare 30A

Fuel Heater Relay	ECU Relay
----------------------	-----------

LF1O623A

There are marks for the fuse capacity and location on the cover of the fuse panel. Replace the fuse according to the following procedure:

1. Turn the key switch to the "OFF" position and turn off all the electrical devices.
2. Open the fuse box cover and check the fuse in question using fuse tongs.

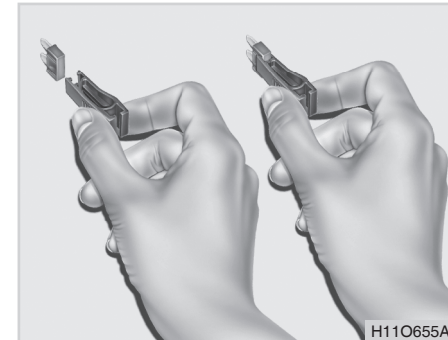

H11O655A

3. If the fuse is blown, replace it with a new fuse with same capacity. Make sure it is firmly installed.
4. Install the fuse box cover.

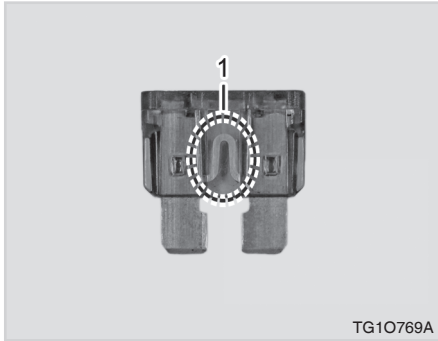

(1) Normal fuse

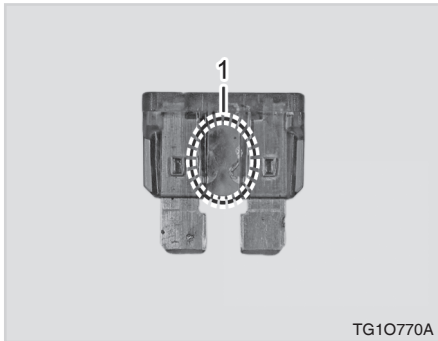

(1) Blown fuse

⚠ WARNING

- **Never use a fuse with the capacity higher than specified on the fuse box cover.**
- **If using a faulty fuse, steel wire, or foil, the electrical device can be damaged or even can catch a fire.**

📖 NOTE

- If the replaced fuse blows immediately after replacement, the wiring system is faulty. In this case, contact your local **KIOTI Dealer**.
- If the fusible link, relay or other electric component is defective, contact your local **KIOTI Dealer**.

BODY RELAY

Start 시동	Pilot Lock Travel Relay (SSL) 파일럿락 주행(SSL)
Electric Fan 전동팬	Pilot Lock Bucket 파일럿락 버킷
Horn 경음기	Quick Attach Lock (Option) 퀵어태치 잠금(옵션)
Back Buzzer 후방부저	Quick Attach Unlock (Option) 퀵어태치 풀림(옵션)
BRAKE LAMP 정지등	

LF1O625D

6

In case of relay defects, the machine will not work normally. Please have it checked at a nearby dealer.

CABIN & CANOPY RELAY



1) Cabin relay box

NOTE

- If the relay or other electric component is defective, contact your local **KIOTI Dealer**.

DOOR SENSOR (LOW PROFILE) 도어센서 (저전고)	SELF LEVELING (OPTION) 셀프레벨링 (옵션)
POWER3 전원3	PARKING 주차
2 SPEED (OPTION) 2 스피드 (옵션)	REAR WORK LAMP (OPTION) 후방작업등 (옵션)
RIDE CONTROL (OPTION) 라이드컨트롤 (옵션)	FRONT WORK LAMP 전방작업등
HI FLOW (OPTION) 하이플로우 (옵션)	BEACON (OPTION) 경광등 (옵션)

LF1O625B

SLOW BLOW FUSE



(1) Slow Blow Fuse

The slow blow fuse is to protect the electric wiring. If it is blown, find and repair the cause and replace it with a new genuine part.

Slow blow fuse

Engine / Start	40A / 30A
Glow / Power	80A / 100A
Lamp / Power 2	60A / 70A

**⊕ IMPORTANT**

- **Using a non-approved slow blow fuse can damage electrical systems in the machine severely.**
- **Refer to the chapter “Troubleshooting” in this manual or contact your local KIOTI Dealer for specific information dealing with electrical problems.**

REPLACE THE BULB

The bulbs and their capacity used in this machine are listed in the below table.

Se-quence	Bulb	Capacity
1	Stop lamps / tail lamps	21W/5W
2	Turn signal lamp	21W
3	Interior lamp	10W

WORK LAMP (FRT/RR)

The LED work lamp is installed to improve visibility for working in low light conditions. If replacement is needed, the whole work lamp assembly needs to be replaced.

**CAUTION**

- **Make sure to use a KIOTI genuine lamp. Using a non-recommended lamp can cause a fire.**



(1) LED work lamp (2) Wiring
(3) Work lamp mounting bracket

1. Turn the key switch "OFF" and remove the LED work lamp assembly from the work lamp mounting bracket.
2. Remove the connector and replace it with a new LED work lamp.

INTERIOR LAMP



(1) Interior lamp

1. Insert a flathead screw driver into the gap of the interior lamp to remove the interior lamp cover.



(1) Interior lamp bulb

2. Pull up and remove the interior lamp bulb, and replace it with a new bulb.



FRONT TURN SIGNAL LAMP



(1) Front turn signal lamp

1. The turn signal lamp (front) is installed on the front cabin frame.

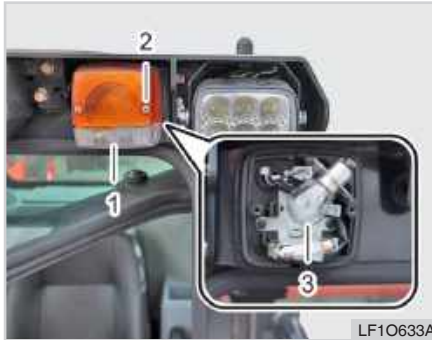

- (1) Turn signal lamp (front)
- (2) Mounting bolt
- (3) Turn signal lamp (front) bulb

2. Unscrew the two mounting bolts to remove the lens.
3. Turn the bulb counterclockwise and remove the bulb body.
4. Remove the bulb by pressing it gently, replace it with a new bulb, and place the socket to the groove and turn it clockwise to install it.

BRAKE LAMP AND REAR TURN SIGNAL LAMP



1) Brake lamp and turn signal lamp

1. The brake lamp and the rear turn signal lamp are installed on the rear cover.



- 1) Brake lamp and turn signal lamp
 (2) Screw (3) Brake lamp bulb
 (4) Turn signal lamp bulb

2. Loosen the screw and remove the cover.
3. Turn the socket counterclockwise to remove the bulb and replace it with a new one.

REFRIGERANT INSPECTION

Insufficient refrigerant degrades the A/C performance. Excessive amount of refrigerant also damages the A/C system, and therefore, if any defect is identified, have it checked at a local **KIOTI** service center immediately.

1. Operate the A/C in the following spec.
 - Engine RPM: About 1,500 rpm
 - Temperature control switch: At the point of maximum cooling temperature
 - Blower speed control dial: Step 4
 - A/C switch: "ON"

CAUTION

- **Park the machine on even ground and choke the wheels.**

WARNING

- ***The refrigerant is at high pressure, and therefore, make sure to have only a certified specialist repair the A/C. An injury can occur.***



STORAGE AND DISPOSAL

STORAGE OF MACHINE	7-2
BEFORE STORAGE	7-2
WHILE IN STORAGE	7-2
AFTER STORAGE	7-3
USAGE AND DISPOSAL.....	7-3

7

7



STORAGE OF MACHINE BEFORE STORAGE

For the long-term storage of the machine, perform minimum maintenance and check to see if it works before storing it.

1. All parts should be cleaned and dried, and the machine should be stored in a dry indoor storage space. Never place the machine outside. If outdoor storage is absolutely necessary, place wood panels on the ground, place the machine on them and cover it with canvas, etc..
2. Replenish the fuel and oil fully and change oil before storage.
3. Apply a thin film of grease on the metallic surface. (Especially, all piston rods of hydraulic cylinders.)
4. Disconnect the battery terminals, cover the battery and store it separately from the machine.
5. If the surrounding temperature is at or below 0°C, make sure to check if anti-freeze is in the coolant.

6. Place the key switch to “OFF” and turn the engine acceleration dial to low-speed idling position.
7. Turn the battery disconnect to off.

WHILE IN STORAGE

1. Run the machine once a month to prevent the oil film from being removed.
2. Wipe the grease on all of the hydraulic piston rods before operating the attachment.



CAUTION

- **To prevent rust while the machine is stored indoor, make sure to keep the storage space well ventilated, and to prevent gas pollution when running the machine, open doors and windows.**



USAGE AND DISPOSAL

AFTER STORAGE

When taking out the machine after long-term storage, follow the procedures below.

1. Wipe the grease on all of the hydraulic piston rods.
2. Fill up the fuel and replenish fuel system.
3. Start and warm up the engine sufficiently, then check all parts thoroughly before use.

In order to protect the environment, use and dispose of the machine keeping the following in mind:

1. When changing the oil or coolant by yourself, be careful not to spill it and dispose used oil and coolant properly according to the applicable regulations.
2. Never leave or discard the expired machine or attachment, but dispose it according to the regulations.
3. Avoid working under high load as it can cause excessive exhaust gas, which is harmful to the environment.

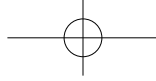

MEMO

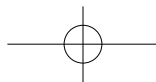



TROUBLESHOOTING

ENGINE TROUBLESHOOTING	8-2
MACHINE TROUBLESHOOTING	8-4
ERROR CODE	8-5

8

8



This troubleshooting chart summarizes simple service items for users who are familiar with mechanical systems. For more detailed service items, contact your local **KIOTI** Dealer.

ENGINE TROUBLESHOOTING

Cause		Countermeasures
1. When engine is difficult to start	• Fuel is thick and doesn't flow.	• Check the fuel tank and fuel filter.
		• Remove water, dirt and other impurities.
		• As all fuel will be filtered by the filter, if there should be water or other foreign matters on the filter, replace the filter.
	• Air or water mixed in fuel system.	• If air is in the fuel filter or injection lines, the fuel pump will not work properly.
		• To obtain proper fuel injection pressure, unscrew the fuel cap nut and inspect the system.
		• Loosen air vent screw over fuel filter and fuel injection pump to eliminate all the air in the fuel system.
	• Thick carbon deposits on orifice of injection nozzle.	• Contact your KIOTI dealer
• Valve clearance is wrong	• Contact your local dealer.	
• Engine oil becomes thick in cold weather and engine cranks slow.	• Change grade of oil according to the weather (temperature).	

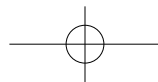

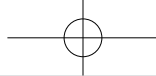

Cause	Countermeasures
1. When engine is difficult to start	• Start motor does not rotate when key switch is turned
	• If the switch or start motor is faulty, have it repaired in at your local KIOTI dealer. • If any terminal is loose or corroded, clean or fix it firmly.
2. When power is insufficient	• Valve out of adjustment
	• Air cleaner is dirty
	• Fuel injection pressure is wrong
3. When color of exhaust is specially bad	• Fuel is of extremely poor quality
	• Nozzle is faulty

※ If you have any question, contact your **KIOTI** Dealer.



MACHINE TROUBLESHOOTING

Cause		Countermeasures
1. When the machine does not move while engine is running	<ul style="list-style-type: none"> • Parking brake is applied 	<ul style="list-style-type: none"> • Release the parking brake.
2. Hydraulic system is faulty	<ul style="list-style-type: none"> • Oil is leaked from pipe or hose 	<ul style="list-style-type: none"> • The pipe clamp is loose. Re-tighten it.
		<ul style="list-style-type: none"> • The pipe is cracked. Have it repaired in a workshop.
3. Electric system is faulty	<ul style="list-style-type: none"> • Headlamps cannot be turned on or are dim. 	<ul style="list-style-type: none"> • The fuse is blown. Check the wiring and replace the fuse.
		<ul style="list-style-type: none"> • The bulb is blown. Replace it
		<ul style="list-style-type: none"> • The ground and terminal wirings are poorly contacted. Check and clean them.
		<ul style="list-style-type: none"> • The battery electrolyte level is low. Charge the battery.
	<ul style="list-style-type: none"> • Battery cannot be charged 	<ul style="list-style-type: none"> • Check the battery and alternator.
	<ul style="list-style-type: none"> • Horn does not sound 	<ul style="list-style-type: none"> • The horn switch is faulty. Replace it.
		<ul style="list-style-type: none"> • The wiring is faulty. Repair it.
		<ul style="list-style-type: none"> • The horn is damaged. Repair or replace it.
	<ul style="list-style-type: none"> • Turn signal lamps do not blink 	<ul style="list-style-type: none"> • The bulb is blown. Replace it.
		<ul style="list-style-type: none"> • The blinking device is faulty. Repair or replace it.
<ul style="list-style-type: none"> • The ground and terminal wirings are poorly contacted. Check and clean them. 		
<ul style="list-style-type: none"> • Work lamps do not come on 	<ul style="list-style-type: none"> • The bulb is blown. Replace it. 	
<ul style="list-style-type: none"> • Work lamps do not come on 	<ul style="list-style-type: none"> • The ground and terminal wirings are poorly contacted. Check and clean them. 	

※ If you have any question, contact your **KIOTI** Dealer.

**ERROR CODE**

SPN	FMI	Fault name	Description	CEL "ON"	DELAYED ENGINE STOP (20s)	LIMP HOME (1400rpm)	Emission Failure Lamp "ON"	Provisional measu- er and correction
262	6	INTAKE AIR PRESSURE SEN- SOR FAULT	Intake manifold pressure sen- sor signal drift fault.	O				Please contact your local dealer
262	5		Intake manifold pressure sen- sor signal drift fault.	O				Please contact your local dealer
263	20	INTAKE AIR PRESSURE SEN- SOR SC2G FAULT	Intake manifold pressure sen- sor plausibility fault.	O				Please contact your local dealer
264	18	INTAKE AIR PRESS. SENSOR OC OR SC2VBATT FAULT	Intake manifold pressure sensor signal high or short to battery fault.	O				Please contact your local dealer
277	1	COOLANT TEMP. SENSOR PLAUSIBILITY	Coolant temp. sensor plausi- bility fault.	O				Please contact your local dealer
279	20	COOLANT TEMP. SENSOR SC2G FAULT	Coolant temp. sensor signal low fault.					Please contact your local dealer
280	18	COOLANT TEMP. SENSOR OC OR SC2VBATT FAULT	Coolant temp. sensor signal high fault.					Please contact your local dealer
288	23	FOOT PEDAL SIGNAL TRACK1 FAULT	Foot pedal signal track 1 fault.	O		O		Please contact your local dealer
386	20	FUEL TEMP. SENSOR SC2G FAULT	Fuel temperature sensor low fault.					Please contact your local dealer
387	18	FUEL TEMP. SENSOR OC OR SC2VBATT FAULT	Fuel temperature sensor high fault.	O				Please contact your local dealer



SPN	FMI	Fault name	Description	CEL "ON"	DELAYED ENGINE STOP (20s)	LIMP HOME (1400rpm)	Emission Failure Lamp "ON"	Provisional measurer and correction
402	20	RAIL PRESSURE SENSOR SIGNAL SC2G FAULT	Rail pressure sensor signal low fault.	○	○			Please contact your local dealer
403	18	RAIL PRESSURE SENSOR SIGNAL OC OR SC2VATT FAULT	Rail pressure sensor signal high fault.	○	○			Please contact your local dealer
513	18	INJECTOR 0 OPEN CIRCUIT FAULT	No. 1 injector is failed, no power and engine speed is limited.	○				Please contact your local dealer
513	19	INJECTOR 0 SHORT CIRCUIT FAULT	No. 1 injector is failed, no power and engine speed is limited.	○				Please contact your local dealer
514	18	INJECTOR 3 OPEN CIRCUIT FAULT	No. 2 injector is failed, no power and engine speed is limited.	○				Please contact your local dealer
514	19	INJECTOR 3 SHORT CIRCUIT FAULT	No. 2 injector is failed, no power and engine speed is limited.	○				Please contact your local dealer
515	18	INJECTOR 1 OPEN CIRCUIT FAULT	No. 3 injector is failed, no power and engine speed is limited.	○				Please contact your local dealer
515	19	INJECTOR 1 SHORT CIRCUIT FAULT	No. 3 injector is failed, no power and engine speed is limited.	○				Please contact your local dealer
516	18	INJECTOR 2 OPEN CIRCUIT FAULT	No. 4 injector is failed, no power and engine speed is limited.	○				Please contact your local dealer
516	19	INJECTOR 2 SHORT CIRCUIT FAULT	No. 4 injector is failed, no power and engine speed is limited.	○				Please contact your local dealer



SPN	FMI	Fault name	Description	CEL "ON"	DELAYED ENGINE STOP (20s)	LIMP HOME (1400rpm)	Emission Failure Lamp "ON"	Provisional measure and correction
544	24	FOOT PEDAL SIGNAL TRACK 2 FAULT	Foot pedal signal track 2 is fault.	○		○		Please contact your local dealer
805	1	KNOCK SENSOR 1 FAULT	No. 1 of Knock sensor signal or noise ratio is too low in idle.	○				Please contact your local dealer
816	1	KNOCK SENSOR 2 FAULT	No. 2 of Knock sensor 2 signal or noise ratio is too low in idle.	○				Please contact your local dealer
1027	1	EGR CONTROL AND SIGNAL FAULT	1. EGR position control fault. 2. EGR H-bridge driver open circuit (OC). 3. EGR H-bridge driver short circuit to ground (SC2G). 4. EGR H-bridge driver short circuit to battery voltage (SC2VBAT).	○			○	Please contact your local dealer
1027	20	EGR SC2G FAULT		○			○	Please contact your local dealer
1027	21	EGR SC2VBATT FAULT		○			○	Please contact your local dealer
1027	3	EGR H-BRIDGE DRIVER FAULT		○			○	Please contact your local dealer
1027	3	EGR H-BRIDGE DRIVER FAULT		○			○	Please contact your local dealer
1027	4	EGR H-BRIDGE DRIVER FAULT		○			○	Please contact your local dealer
1314	5	ENGINE OIL PRESSURE LOW FAULT	At engine run, oil pressure remains low. Oil pressure warning lamp will come on.		○			please check the engine oil level and fill in if necessary or contact your local dealer.



SPN	FMI	Fault name	Description	CEL "ON"	DELAYED ENGINE STOP (20s)	LIMP HOME (1400rpm)	Emission Failure Lamp "ON"	Provisional measurer and correction
1378	4	BATTERY VOLTAGE LOW FAULT	Battery voltage is lower than specs.					Please contact your local dealer
1379	4	BATTERY VOLTAGE HIGH FAULT	Battery voltage is higher than specs.	O				Please contact your local dealer
1581	20	INJECTOR DRIVER CIRCUIT PERFORMANCE BANK 'A' FAULT	Injector 1&3 or wires are failed.	O				Please contact your local dealer
1581	21	INJECTOR DRIVER CIRCUIT PERFORMANCE BANK 'A' FAULT		O				Please contact your local dealer
1581	1	INJECTOR DRIVER CIRCUIT PERFORMANCE BANK 'A' FAULT		O		O		Please contact your local dealer
1582	20	INJECTOR DRIVER CIRCUIT PERFORMANCE BANK 'B' FAULT	Injector 2&4 or wires are failed.	O				Please contact your local dealer
1582	21	INJECTOR DRIVER CIRCUIT PERFORMANCE BANK 'B' FAULT		O				Please contact your local dealer
1582	1	INJECTOR DRIVER CIRCUIT PERFORMANCE BANK 'B' FAULT		O		O		Please contact your local dealer



SPN	FMI	Fault name	Description	CEL "ON"	DELAYED ENGINE STOP (20s)	LIMP HOME (1400rpm)	Emission Failure Lamp "ON"	Provisional measurer and correction
1601	26	ECU INTERNAL 5V SUPPLY 1 FAULT	ECU internal 5V supply 1 is fault.	O				Please contact your local dealer
1601	26	ECU INTERNAL 5V SUPPLY 1 FAULT		O				Please contact your local dealer
1617	26	ECU INTERNAL 5V SUPPLY 2 FAULT	ECU internal 5V supply 2 is fault.	O				Please contact your local dealer
1617	26	ECU INTERNAL 5V SUPPLY 2 FAULT		O				Please contact your local dealer
1687	26	ECU INTERNAL 5V AUXILLARY FAULT	ECU internal 5V supply to auxiliary is fault.	O				Please contact your local dealer
1687	26	ECU INTERNAL 5V AUXILLARY FAULT		O				Please contact your local dealer
4641	25	FOOT PEDAL LIMP HOME FAULT	Foot pedal signal fault, it cause limp home mode of vihecle.	O		O		Please contact your local dealer
4644	25	HAND PEDAL LIMP HOME FAULT		O		O		Please contact your local dealer
5702	1	PTO CRUISE SWITCH FAULT	PTO cruise and ajust switches are fault or wires are failed.					Please contact your local dealer

SPN	FMI	Fault name	Description	CEL "ON"	DELAYED ENGINE STOP (20s)	LIMP HOME (1400rpm)	Emission Failure Lamp "ON"	Provisional measurer and correction
5703	1	PTO CRUISE DEC/SET SWITCH FAULT	PTO cruise DECREASE switch is fault. Or wire is failed.					Please contact your local dealer
5703	22	PTO CRUISE DEC/SET SWITCH FAULT						Please contact your local dealer
5703	20	PTO CRUISE DEC/SET SWITCH FAULT						Please contact your local dealer
5704	1	PTO CRUISE INC/RESUME SWITCH FAULT	PTO cruise INCREASE switch is fault. Or wire is failed.					Please contact your local dealer
5704	22	PTO CRUISE INC/RESUME SWITCH FAULT						Please contact your local dealer
5704	20	PTO CRUISE INC/RESUME SWITCH FAULT						Please contact your local dealer
8194	28	DPF OVERLOAD FAULT	DPF overload fault.					Please contact your local dealer
8241	1	DPF IN TEMP. SENSOR SIGNAL FAULT	Temperature sensor in DPF is fault.	O				Please contact your local dealer
8242	20	DPF IN TEMP. SENSOR SC2G FAULT	Temperature sensor in DPF is fault like cut.					Please contact your local dealer
8243	18	DPF IN TEMP. SENSOR OC OR SC2VBATT FAULT	Temperature sensor in DPF is fault like shorted.					Please contact your local dealer



SPN	FMI	Fault name	Description	CEL "ON"	DELAYED ENGINE STOP (20s)	LIMP HOME (1400rpm)	Emission Failure Lamp "ON"	Provisional measurer and correction
8450	20	ACV H-BRIDGE DRIVER FAULT	ACV H-Bridge driver is short to ground fault.	○				Please contact your local dealer
8451	21	ACV H-BRIDGE DRIVER FAULT		○				Please contact your local dealer
8472	3	ACV H-BRIDGE DRIVER FAULT	ACV driver circuit is fault.	○				Please contact your local dealer
8472	3	ACV H-BRIDGE DRIVER FAULT		○				Please contact your local dealer
8473	7	ACV CONTROL FAULT	ACV control fault.	○				Please contact your local dealer
8480	23	HAND PEDAL SIGNAL TRACK1 FAULT	Main signal of Hand accelerator is fault.	○		○		Please contact your local dealer
8485	24	HAND PEDAL SIGNAL TRACK2 FAULT	Secondary signal of Hand accelerator is fault.	○		○		Please contact your local dealer
8804	8	WATER IN FUEL SENSOR FEEDBACK FAULT	Feedback signal of water sensor in fuel filter is Short to circuit to ground fault.	○				Please contact your local dealer
8804	9	WATER IN FUEL SENSOR FEEDBACK FAULT		○				Please contact your local dealer
8809	1	WATER IN FUEL SENSOR DETECT FAULT	Water in fuel sensor detected.			○		Please drain water from filter or Please contact your local dealer

SPN	FMI	Fault name	Description	CEL "ON"	DELAYED ENGINE STOP (20s)	LIMP HOME (1400rpm)	Emission Failure Lamp "ON"	Provisional measure and correction
9263	28	DPF PLUGGED FAULT	DPF plugged fault.	O				Please contact your local dealer
9299	1	DPF DIFF.PRESS SENSOR PLAUSIBILITY FAULT	DPF differential pressure sensor signal is plausibility fault.	O				Please contact your local dealer
9299	22	DPF DIFF.PRESS SENSOR PLAUSIBILITY FAULT		O				Please contact your local dealer
9300	20	DPF DIFF. PRESS SENSOR SC2G FAULT	DPF differential pressure sensor signal is low.	O				Please contact your local dealer
9301	18	DPF DIFF. PRESS SENSOR OC OR SC2VBATT FAULT	DPF differential pressure sensor signal is high.	O				Please contact your local dealer
9323	1	DPF REGENERATION SWITCH FAULT	DPF regeneration switch is fault.	O				Please contact your local dealer
521015	31	RAIL PRESSURE OVER TIME FAULT	Rail pressure control error during IMV contro, high preesure detected.	O				Please contact your local dealer
1315	7	ENGINE OIL PRESSURE OC FAULT	Rail pressure sensor is in open cercuit.	O				Please contact your local dealer
1315	8	ENGINE OIL PRESSURE SC FAULT	Rail pressure sensor is in short cercuit.	O				Please contact your local dealer



INDEX

INDEX..... 9-2

9

9



NUMERIC

14-PIN AUXILIARY POWER OUTLET4-24

A

A/C MAINTENANCE.....4-58

A/C REFRIGERANT AND LUBRICANT SPEC.....4-59

A/C SWITCH4-57

A/C SWITCH (CABIN MODEL ONLY).....4-17

ACCESSORIES4-54

ADJUSTING FAN BELT TENSION.....6-20

ADJUSTING THE SEAT4-60

AFTER DAILY WORK IS COMPLETED.....1-29

AFTER STORAGE.....7-3

AIR RECIRCULATION MODE AND FRESH AIR MODE..4-59

ANTENNA.....4-54

ANTI-FREEZE.....6-26

AUX (AUXILIARY HYDRAULICS) PORT SWITCH
SWITCH4-12

AUX ELECTRIC MODE ACTIVATION BUTTON4-20

B

BATTERY6-20

BATTERY CHARGE WARNING LAMP4-35

BATTERY SHUT OFF SWITCH.....6-21

BEACON LAMP SWITCH (OPTIONAL).....4-16

BEFORE OPERATION2-1

BEFORE STORAGE.....7-2

BELTS AND RUBBER PARTS2-3

BLEEDING FUEL SYSTEM6-26

BLOWER SPEED CONTROL DIAL.....4-57

BODY FUSE.....6-30

BODY RELAY6-31

BOOM LOCK.....4-64

BRAKE LAMP AND REAR TURN SIGNAL LAMP6-35

C

CABIN & CANOPY.....4-51

CABIN & CANOPY RELAY6-32

CAUTIONS FOR DECAL MAINTENANCE1-39

CHANGING ENGINE OIL AND REPLACING FILTER....6-8

CHARGING6-22

CHECK ENGINE WARNING LAMP4-32

CHECK ITEMS.....5-2

CHECKING AND ADDING FUEL.....6-6

CHECKING AND REPLACING CHAIN CASE OIL.....6-13

CHECKING AND REPLACING WIPERS (CABIN
MODEL ONLY).....6-28

CHECKING ENGINE OIL LEVEL6-7



CHECKING FUEL LINE	6-19
CHECKING GAUGES, METERS AND INDICATORS.....	6-14
CHECKING HEAD LIGHT, HAZARD LIGHT ETC.....	6-14
CHECKING INTAKE AIR LINE	6-23
CHECKING RADIATOR HOSE AND CLAMP	6-23
CHECKING SEAT BELT AND CABIN	6-14
CHECKING THE COOLANT LEVEL	6-13
CHECKING THE HYDRAULIC OIL LEVEL	6-10
CHECKING THE MONITOR	4-48
CHECKING WARNING LAMPS.....	5-6
CHECKING WHEEL BOLT/NUT TORQUE	6-16
CLEANING AND REPLACING AIR CLEANER FILTER ..	6-17
CLEANING THE RADIATOR	6-14
CONTROLS.....	4-18
CUP HOLDER AND STORAGE SPACE	4-55
CUSHION STRENGTH ADJUSTMENT	4-60
D	
DAILY CHECK ITEM.....	6-2
DECAL MOUNTING LOCATION	1-33
DESCRIPTION.....	1-35
DIGGING	5-17
DIRECTION FOR STORAGE	6-22
DOOR (CABIN MODEL ONLY).....	4-52

DOOR STOPPER (CABIN MODEL ONLY).....	4-52
DPF REGENERATION PROCESS INDICATOR.....	4-33
DPF REGENERATION SWITCH	4-15
DPF REGENERATION WARNING LAMP.....	4-33
DRIVING.....	1-21
DRIVING AND OPERATION	5-8
DRIVING INSTRUCTIONS	5-1
DRIVING ON ROADS.....	1-24
DRIVING ON SLOPES	5-11
DUMPING.....	5-19
E	
EMERGENCY EXIT	4-62
ENGINE ACCELERATION DIAL.....	4-8
ENGINE COOLANT TEMPERATURE GAUGE	4-29
ENGINE OIL PRESSURE WARNING LAMP	4-31
ENGINE PRE-HEATING INDICATOR.....	4-32
ENGINE SERIAL NUMBER	2-2
ENGINE TROUBLESHOOTING	8-2
ENTER SWITCH.....	4-30
ERROR CODE	8-5
ESC / BUZZER OFF BUTTON.....	4-31
ESSENTIAL REPLACEMENT PARTS	2-3
EXTERIOR DEVICES	4-51



E

EXTERIOR VIEW4-3
 EXTERNAL DIMENSIONS.....3-2

F

FILLING THE BUCKET5-16
 FILTERS2-4
 FLOAT.....5-18
 FLUSHING COOLING SYSTEM AND CHANGING
 COOLANT.....6-24
 FOR LONG-TERM STORAGE.....1-31
 FOR SAFE OPERATION.....1-1
 FORWARD AND REVERSE DRIVING.....5-10
 FUEL FILTER6-16
 FUEL GAUGE4-28
 FUNCTION DESCRIPTION AND OPERATING TIPS.....4-1

G

GENERAL PRECAUTIONS1-2
 GENERAL SPECIFICATIONS3-3
 GREASING INSTRUCTIONS6-15

H

HAZARD FLASHER4-31

HAZARD WARNING FLASHER SWITCH4-12
 HEATER AND A/C (CABIN MODEL ONLY)4-56
 HIGH FLOW SWITCH4-13
 HOW TO OPERATE EXTERNAL HYDRAULIC PRES-
 SURE.....4-23
 HOW TO OPERATE THE AUXILIARY POWER4-25
 HOW TO OPERATE THE HIGH FLOW FUNCTION.....4-24
 HOW TO WARM UP5-7
 HYDRAULIC LOCK SWITCH4-14
 HYDRAULIC OIL TEMPERATURE GAUGE.....4-28
 HYDRAULIC QUICK ATTACH SYSTEM (IF INSTALLED).....4-14
 HYDRAULIC UNLOCK SAFETY SWITCH4-8

I

INDEX9-2
 INITIAL OPERATION.....5-2
 INSTALLING AND OPERATING ATTACHMENT.....1-14
 INSTALLING AND REMOVING THE BUCKET (HY-
 DRAULIC QUICK ATTACH SYSTEM)4-64
 INSTRUMENT PANEL.....4-26
 INSTRUMENT PANEL FEATURES4-26
 INTERIOR DEVICES (CABIN MODEL ONLY)4-51
 INTERIOR LAMP6-34
 INTERIOR LAMP4-54



INTERIOR LAMP SWITCH4-17

J

JOYSTICK CONTROL LEVER BUTTON OPERATION ..4-19

JOYSTICK CONTROL LEVER BUTTON OPERATION ..4-21

JOYSTICK CONTROL LEVER OPERATION4-19

JOYSTICK CONTROL LEVER OPERATION4-21

JUMP STARTING5-7

K

KEY SWITCH4-7

L

LEFT JOYSTICK CONTROL LEVER (DRIVING).....4-20

LEFT/RIGHT MENU SWITCH/CAMERA SWITCH4-30

LEVELING5-18

LIFTING THE MACHINE5-15

LOADING AND UNLOADING A TRANSPORTING
TRUCK1-27

LOADING AND UNLOADING THE MACHINE TO/
FROM A TRUCK5-14

LOWERING THE CANOPY AND THE CABIN.....4-68

LUBRICANTS6-5

M

MACHINE DIAGNOSIS4-48

MACHINE TROUBLESHOOTING8-4

MAIN AND SUB-MENU4-37

MAINTENANCE6-1

MAINTENANCE CHECK LIST.....6-2

MAINTENANCE CODE6-6

MAINTENANCE SCHEDULE CHART6-3

MANUAL QUICK ATTACH SYSTEM.....4-63

MCU (MACHINE CONTROL UNIT).....4-62

MENU SWITCH4-30

MOUNTING LOCATION4-5

O

OILS AND FLUIDS2-3

OPENING THE REAR DOOR.....6-6

OPERATING THE ENGINE5-3

OPERATION5-16

OPERATION BEFORE DRIVING5-8

OPTION LIST AND FEATURES3-5

OTHER COMPONENTS2-4

P

PARKING BRAKE LAMP.....4-34



P

PARKING SWITCH.....4-9
 POWER SOCKET & USB SOCKET4-54
 PRECAUTIONS FOR HANDLING.....6-20
 PRECAUTIONS WHILE DRIVING ON THE ROAD5-13
 PRE-OPERATION CHECK5-2
 PRODUCTION SERIAL NUMBER2-2

R

RADIO & USB PLAYER (CABIN MODEL ONLY - OP-
 TIONAL)4-55
 RAISING THE CANOPY AND CABIN4-67
 REAR-VIEW CAMERA4-36
 REFRIGERANT INSPECTION6-36
 RELEASING THE LIFT ARM4-66
 REMOVING THE BUCKET (MANUAL TYPE)4-63
 REMOVING WATER FROM FUEL FILTER6-16
 REPLACE THE BULB6-33
 REPLACING FUEL FILTER6-17
 REPLACING THE HYDRAULIC OIL AND FILTER6-11
 RIGHT JOYSTICK CONTROL LEVER (LIFT ARM &
 BUCKET).....4-19

S

SAFETY BAR WARNING LAMP.....4-35

SAFETY COVER WARNING LAMP4-34
 SAFETY DECAL MAINTENANCE.....1-33
 SAFETY PRECAUTIONS1-2
 SAFETY PRECAUTIONS DURING THE STORAGE
 OF THE MACHINE1-29
 SAFETY PRECAUTIONS WHILE OPERATING THE
 MACHINE.....1-13
 SEAT ADJUSTMENT4-60
 SEAT BAR4-60
 SEAT BELT4-61
 SELF-LEVELING SWITCH (IF INSTALLED).....4-11
 SERVICE, INSPECTION & MAINTENANCE.....1-7
 SLOW BLOW FUSE6-32
 SPECIFICATIONS3-1
 SPECIFICATIONS3-2
 STARTING ENGINE5-3
 STARTING THE ENGINE.....1-13
 STOPPING ENGINE5-6
 STORAGE AND DISPOSAL7-1
 STORAGE OF MACHINE7-2
 SWITCHES.....4-5

T

TACHOMETER/HOUR METER4-28



TEMPERATURE CONTROL DIAL4-57
 THROTTLE PEDAL4-26
 TIPS FOR BREAKING-IN5-2
 TIRE INFLATION PRESSURE4-70
 TIRES4-69
 TROUBLESHOOTING8-1
 TURN SIGNAL LAMP SWITCH4-10
 TURNING5-11

U

USAGE AND DISPOSAL7-3

V

VEHICLE IDENTIFICATION NUMBER2-2

W

WARMING UP5-7
 WATER-IN-FUEL WARNING LAMP4-33
 WHEEL INSTALLATION4-70
 WHEEL TORQUE4-70
 WHEN OPERATING ON SLOPES OR UNEVEN TER-
 RAIN1-24
 WHILE IN STORAGE7-2
 WIPER (CABIN MODEL ONLY)4-53

WIPER/WASHER SWITCH (CABIN MODEL ONLY)4-11
 WORK LAMP4-52
 WORK LAMP (FRT/RR)6-33
 WORK LIGHTS SWITCH4-9

